

**SEKTION A**  
ALLGEMEINCHIRURGIE



**SECTION A**  
GENERAL SURGERY

**SECCIÓN A**  
CIRUGÍA GENERAL

<b>Inhaltsverzeichnis</b>	<b>Contents</b>	<b>Contenido</b>		
<b>Sektion A</b>	<b>Section A</b>	<b>Sección A</b>		<b>Seite, Page, Página</b>
Chirurgische Scheren Präparierscheren	Surgical Scissors Dissecting Scissors	Tijeras quirúrgicas Tijeras de disección	<b>AA</b>	A.01 - A.11
Spezialscheren	Special Scissors	Tijeras especiales	<b>AB</b>	A.11 - A.25
<b>GEOMED® GOLD-CUT®</b> plus <b>GEOMED® GOLD-CUT®</b> super <b>GEOMED® GOLD-CUT®</b> super plus <b>GEOMED® GOLD-CUT®</b> Scheren	<b>GEOMED® GOLD-CUT®</b> plus <b>GEOMED® GOLD-CUT®</b> super <b>GEOMED® GOLD-CUT®</b> super plus <b>GEOMED® GOLD-CUT®</b> Scissors	<b>GEOMED® GOLD-CUT®</b> plus <b>GEOMED® GOLD-CUT®</b> super <b>GEOMED® GOLD-CUT®</b> super plus <b>GEOMED® GOLD-CUT®</b> Tijeras	<b>AD</b>	A.26 - A.46
Pinzetten	Dressing and Tissue Forceps	Pinzas de disección	<b>AE</b>	A.47 - A.58
Pinzetten	Dressing and Tissue Forceps	Pinzas de disección	<b>AF</b>	A.59 - A.63
<b>GEOMED® GOLD-GRIP®</b> Pinzetten	<b>GEOMED® GOLD-GRIP®</b> Dressing and Tissue Forceps	<b>GEOMED® GOLD-GRIP®</b> Pinzas de disección	<b>AH</b>	A.64 - A.65
Bulldog-, Arterien-, Präparier- und Ligaturklemmen, gynäko- logische Klemmen	Bulldog, Hemostatic, Dissecting and Ligature Forceps, Gynecological Clamps	Pinzas bulldog, Hemostáticas, pinzas de disección y ligaduras, pinzas para ginecología	<b>AI</b>	A.66 - A.89
Tuchklemmen Schlauchklemmen	Towel Forceps Tubing Clamps	Pinzas de campo Pinzas cierra-tubos	<b>AK</b>	A.90 - A.93
Tupferzangen	Sponge Holding Forceps	Pinzas para tapones	<b>AL</b>	A.94 - A.97
Nadelhalter Nahtinstrumente	Needle Holders Suture Instruments	Porta-agujas Instrumental para suturas	<b>AN</b>	A.98 - A.109
<b>GEOMED® GOLD-GRIP®</b> Nadelhalter	<b>GEOMED® GOLD-GRIP®</b> Needle Holders	<b>GEOMED® GOLD-GRIP®</b> Porta-agujas	<b>AR</b>	A.110 - A.119
Skalpelli Chirurgische Messer	Scalpel Handles Knives	Mangos de bisturíes Cuchillos	<b>AS</b>	A.120 - A.123
Saugrohre	Suction Tubes	Tubos de aspiración	<b>AT</b>	A.124 - A.128
Trokare, Spezialkanülen Wund- und Blasenspritzen	Trocars, Special Needles, Wound and bladder Syringes	Trocares, Agujas especiales Jeringas para enjugar la vejiga y herida	<b>AU</b>	A.129 - A.135
Sonden und Watteträger	Probes and Cotton Applicators	Estiletes y porta-algodones	<b>AW</b>	A.136 - A.139
Wundhaken, Atriumhaken, Bauchspatel	Retractors, Atrium Retractors, Abdominal Spatulas	Separadores, Separadores para atrio, Espátulos abdominales	<b>AX</b>	A.140 - A.173
Wundsperrer Bauchdeckenhalter	Self-Retaining Retractors Abdominal Retractors	Separadores autostáticos Separadores abdominales	<b>AZ</b>	A.174 - A.196
<b>Mikro-Instrumente</b>	<b>Micro Instruments</b>	<b>Instrumentos para micro quirúrgicas</b>		
Mikroscheren	Micro Scissors	Micro tijeras	<b>AC</b>	
Mikropinzetten	Micro Forceps	Micro pinzas de disección	<b>AG</b>	
Mikronadelhalter	Micro Needle Holders	Micro Porta-agujas	<b>AO</b>	
<b>GEOMED® ASSISTO®</b> Arm-Systeme	<b>GEOMED® ASSISTO®</b> Arm-System	<b>GEOMED® ASSISTO®</b> Sistema Brazo	<b>CA - CI</b>	A.197
Setvorschläge	Set Suggestions	Proposición de Sets	<b>ZA / ZP</b>	A.234 - A.241

**Chirurgische Scheren**  
**Surgical Scissors**  
**Tijeras quirúrgicas**



**Standard**

stumpf/stumpf, gerade

blunt/blunt, straight

roma/roma, recta

AA 100-11 11,5 cm / 4½"

AA 100-13 13 cm / 5"

AA 100-14 14,5 cm / 5¾"

AA 100-16 16,5 cm / 6½"

AA 100-18 18,5 cm / 7"

AA 100-20 20 cm / 8"

gebogen - curved - curva

AA 101-11 11,5 cm / 4½"

AA 101-13 13 cm / 5"

AA 101-14 14,5 cm / 5¾"

AA 101-16 16,5 cm / 6½"

AA 101-18 18,5 cm / 7"

AA 101-20 20 cm / 8"



**Standard**

spitz/stumpf, gerade

sharp/blunt, straight

aguda/roma, recta

AA 102-11 11,5 cm / 4½"

AA 102-13 13 cm / 5"

AA 102-14 14,5 cm / 5¾"

AA 102-16 16,5 cm / 6½"

AA 102-18 18,5 cm / 7"

AA 102-20 20 cm / 8"

gebogen - curved - curva

AA 103-11 11,5 cm / 4½"

AA 103-13 13 cm / 5"

AA 103-14 14,5 cm / 5¾"

AA 103-16 16,5 cm / 6½"

AA 103-18 18,5 cm / 7"

AA 103-20 20 cm / 8"

**Chirurgische Scheren**  
**Surgical Scissors**  
**Tijeras quirúrgicas**



**Standard**

spitz/spitz, gerade  
sharp/sharp, straight  
aguda/aguda, recta

AA 104-11	11,5 cm / 4½"
AA 104-13	13 cm / 5"
AA 104-14	14,5 cm / 5¾"
AA 104-16	16,5 cm / 6½"
AA 104-18	18,5 cm / 7"
AA 104-20	20 cm / 8"

gebogen - curved - curva

AA 105-11	11,5 cm / 4½"
AA 105-13	13 cm / 5"
AA 105-14	14,5 cm / 5¾"
AA 105-16	16,5 cm / 6½"
AA 105-18	18,5 cm / 7"
AA 105-20	20 cm / 8"



**Deaver**

stumpf/stumpf, gerade  
blunt/blunt, straight  
roma/roma, recta

AA 110-14	14 cm / 5½"
-----------	-------------

gebogen - curved - curva

AA 111-14	14 cm / 5½"
-----------	-------------



**Deaver**

spitz/stumpf, gerade  
sharp/blunt, straight  
aguda/roma, recta

AA 112-14	14 cm / 5½"
-----------	-------------

gebogen - curved - curva

AA 113-14	14 cm / 5½"
-----------	-------------

**Chirurgische Scheren**  
**Surgical Scissors**  
**Tijeras quirúrgicas**



**Deaver**

spitz/spitz, gerade  
sharp/sharp, straight  
aguda/aguda, recta

**AA 114-14** 14 cm / 5½"

gebogen - curved - curva

**AA 115-14** 14 cm / 5½"



**Wagner**

stumpf/stumpf, gerade  
blunt/blunt, straight  
roma/roma, recta

**AA 130-12** 12 cm / 4¾"

gebogen - curved - curva

**AA 131-12** 12 cm / 4¾"



**Wagner**

spitz/stumpf, gerade  
sharp/blunt, straight  
aguda/roma, recta

**AA 132-12** 12 cm / 4¾"

gebogen - curved - curva

**AA 133-12** 12 cm / 4¾"



**Wagner**

spitz/spitz, gerade  
sharp/sharp, straight  
aguda/aguda, recta

**AA 134-12** 12 cm / 4¾"

gebogen - curved - curva

**AA 135-12** 12 cm / 4¾"

## Feine chirurgische Scheren

## Fine Surgical Scissors

## Tijeras quirúrgicas finas



### Iris

stumpf/stumpf, gerade

blunt/blunt, straight

roma/roma, recta

AA 140-11 11,5 cm / 4½"

gebogen - curved - curva

AA 141-11 11,5 cm / 4½"



### Iris

spitz/stumpf, gerade

sharp/blunt, straight

aguda/roma, recta

AA 142-11 11,5 cm / 4½"

gebogen - curved - curva

AA 143-11 11,5 cm / 4½"



### Iris

spitz/spitz, gerade

sharp/sharp, straight

aguda/aguda, recta

AA 144-10 10,5 cm / 4¼"

AA 144-11 11,5 cm / 4½"

gebogen - curved - curva

AA 145-10 10,5 cm / 4¼"

AA 145-11 11,5 cm / 4½"



### Iris

spitz/spitz, seitlich gebogen

sharp/sharp, curved to side

aguda/aguda, curva de lado

AA 147-11 11,5 cm / 4½"

**Feine chirurgische Scheren**  
**Fine Surgical Scissors**  
**Tijeras quirúrgicas finas**



**Iris**

spitz/spitz, abgewinkelt  
sharp/sharp, angled to side  
aguda/aguda, angulada

**AA 149-11** 11,5 cm / 4½"



**La Grange**

spitz/spitz, gezahnt  
sharp/sharp, serrated  
aguda/aguda, dentada

gebogen - curved - curva

**AA 151-11** 11,5 cm / 4½"



**Joseph**

spitz/spitz, gerade  
sharp/sharp, straight  
aguda/aguda, recta

**AA 154-14** 14 cm / 5½"

gebogen - curved - curva

**AA 155-14** 14 cm / 5½"



**Kelly**

spitz/spitz, gerade  
sharp/sharp, straight  
aguda/aguda, recta

**AA 164-16** 16 cm / 6¼"

gebogen - curved - curva

**AA 165-16** 16 cm / 6¼"

**Präparierscheren**  
**Dissecting Scissors**  
**Tijeras de disección**



**Mayo**

gerade - straight - recta

AA 170-14 14,5 cm / 5¾"

AA 170-15 15 cm / 6"

AA 170-17 17 cm / 6¾"

AA 170-20 20 cm / 8"

AA 170-23 23 cm / 9"

gebogen - curved - curva

AA 171-14 14,5 cm / 5¾"

AA 171-15 15 cm / 6"

AA 171-17 17 cm / 6¾"

AA 171-20 20 cm / 8"

AA 171-23 23 cm / 9"



**Mayo-Style**

gerade - straight - recta

AA 180-15 15 cm / 6"

AA 180-17 17 cm / 6¾"

AA 180-19 19 cm / 7½"

AA 180-21 21 cm / 8¼"

gebogen - curved - curva

AA 181-15 15 cm / 6"

AA 181-17 17 cm / 6¾"

AA 181-19 19 cm / 7½"

AA 181-21 21 cm / 8¼"



**Mayo-Harrington**

gerade - straight - recta

AA 184-22 22 cm / 8¾"

gebogen - curved - curva

AA 185-22 22 cm / 8¾"



**Präparierscheren**  
**Dissecting Scissors**  
**Tijeras de disección**



**Lexer**

gerade - straight - recta

AA 190-16 16 cm / 6¼"

gebogen - curved - curva

AA 191-16 16 cm / 6¼"



**Metzenbaum**

stumpf/stumpf, gerade

blunt/blunt, straight

roma/roma, recta

AA 200-14 14,5 cm / 5¾"

AA 200-18 18 cm / 7"

AA 200-20 20 cm / 8"

AA 200-23 23 cm / 9"

AA 200-25 25 cm / 10"

AA 200-28 28 cm / 11"

AA 200-30 30 cm / 12"

gebogen - curved - curva

AA 201-14 14,5 cm / 5¾"

AA 201-18 18 cm / 7"

AA 201-20 20 cm / 8"

AA 201-23 23 cm / 9"

AA 201-25 25 cm / 10"

AA 201-28 28 cm / 11"

AA 201-30 30 cm / 12"



**Metzenbaum**

spitz/spitz, gerade

sharp/sharp, straight

aguda/aguda, recta

AA 204-14 14,5 cm / 5¾"

AA 204-18 18 cm / 7"

gebogen - curved - curva

AA 205-14 14,5 cm / 5¾"

AA 205-18 18 cm / 7"

**Präparierscheren**  
**Dissecting Scissors**  
**Tijeras de disección**



**Metzenbaum**

*feines Modell - fine pattern - modelo delgado*

stumpf/stumpf, gerade

blunt/blunt, straight

roma/roma, recta

AA 330-14 14,5 cm / 5¾"

AA 330-18 18 cm / 7"

AA 330-20 20 cm / 8"

AA 330-23 23 cm / 9"

gebogen - curved - curva

AA 331-14 14,5 cm / 5¾"

AA 331-18 18 cm / 7"

AA 331-20 20 cm / 8"

AA 331-23 23 cm / 9"



**Baby-Metzenbaum**

gerade - straight - recta

AA 400-11 11,5 cm / 4½"

gebogen - curved - curva

AA 401-11 11,5 cm / 4½"



**Metzenbaum-Nelson**

gerade - straight - recta

AA 404-25 25 cm / 10"

AA 404-28 28 cm / 11"

gebogen - curved - curva

AA 405-25 25 cm / 10"

AA 405-28 28 cm / 11"

**Präparierscheren**  
**Dissecting Scissors**  
**Tijeras de disección**



**Kilner (Ragnell)**

gebogen - curved - curva

**AA 411-12** 12 cm / 4<sup>3</sup>/<sub>4</sub>"

**AA 411-15** 15 cm / 6"



Nerv-Präparierschere

Nerve Dissecting Scissors

Tijeras para disección de nervios

spitz/spitz, gerade

sharp/sharp, straight

aguda/aguda, recta

**AA 420-15** 15 cm / 6"

spitz/spitz, gebogen

sharp/sharp, curved

aguda/aguda, curva

**AA 421-15** 15 cm / 6"



Enukleationsschere

Enucleation Scissors

Tijera para enucleación

gebogen - curved - curva

**AA 470-11** 11,5 cm / 4<sup>1</sup>/<sub>2</sub>"



**Strabismus**

gerade - straight - recta

**AA 510-11** 11,5 cm / 4<sup>1</sup>/<sub>2</sub>"

gebogen - curved - curva

**AA 511-11** 11,5 cm / 4<sup>1</sup>/<sub>2</sub>"

**Präparierscheren**  
**Dissecting Scissors**  
**Tijeras de disección**



**Strabismus**

*sehr feines Modell, gerade  
very fine pattern, straight  
modelo muy delgado, recto*

**AA 530-11** 11,5 cm / 4½"

gebogen - curved - curva

**AA 531-11** 11,5 cm / 4½"



**Lexer-Baby**

*gerade - straight - recta*

**AA 600-10** 10 cm / 4"

gebogen - curved - curva

**AA 601-10** 10 cm / 4"



**Toennis-Adson**

*gebogen - curved - curva*

**AA 611-17** 17 cm / 6¾"



**Reynolds**

*gerade - straight - recta*

**AA 650-15** 15 cm / 6"

gebogen - curved - curva

**AA 651-15** 15 cm / 6"

**AA 651-18** 18 cm / 7"

**AA 651-20** 20 cm / 8"

**Präparierscheren**  
**Dissecting Scissors**  
**Tijeras de disección**

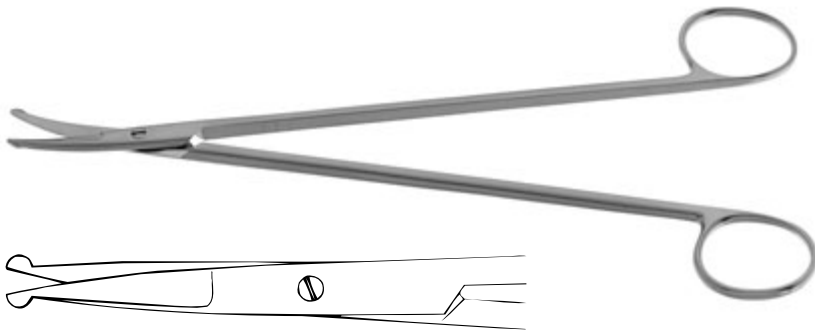

**Stully**  
AA 680-22 22 cm / 8¾"

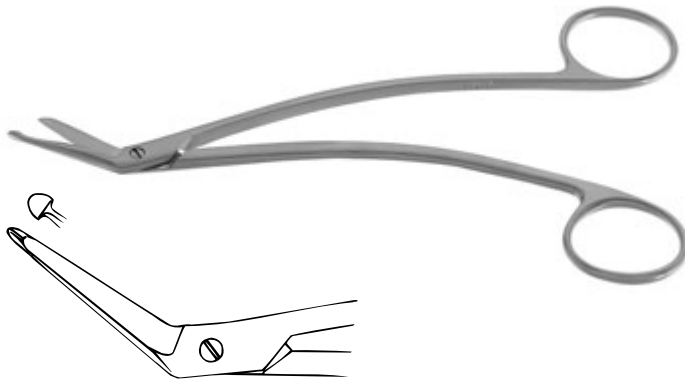

**Schmieden-Taylor**  
AA 691-17 17 cm / 6¾"

**Tonsillen- und Nasenschere**  
**Tonsil and Nasal Scissors**  
**Tijeras amígdalas y nasales**



**Cottle-Masing**

spitz/spitz, gebogen  
sharp/sharp, curved  
aguda/aguda, curva

**AA 701-10** 10,5 cm / 4¼"

stumpf/stumpf, gebogen  
blunt/blunt, curved  
roma/roma, curva

**AA 703-10** 10,5 cm / 4¼"



**Cottle-Knapp**

stumpf/stumpf, gerade  
blunt/blunt, straight  
roma/roma, recta

**AA 706-10** 10,5 cm / 4¼"

stumpf/stumpf, gebogen  
blunt/blunt, curved  
roma/roma, curva

**AA 707-10** 10,5 cm / 4¼"



**Cottle**

**AB 101-16** 16 cm / 6¼"

**Tonsillen- und Nasenscheren**  
**Tonsil and Nasal Scissors**  
**Tijeras amígdalas y nasales**



**Heymann**  
**AB 111-18** 18 cm / 7"



**Fomon**  
abgewinkelt – angled - angulada  
**AB 121-15** 15 cm / 6"



**Fomon**  
gebogen – curved - curva  
**AB 131-13** 13 cm / 5"

**Thoraxscheren**  
**Thoracic Scissors**  
**Tijeras torácicas**



**Thorek**  
stark gebogen - strong curved - curva fuerte  
**AB 141-19** 19 cm / 7½"



**Klingenberg-Loth**  
gebogen – curved – curva  
**AB 145-23** 23 cm / 9"



**Satinsky**  
gebogen - curved - curva  
**AB 151-24** 24,5 cm / 9¾"



**Crafoord**  
gebogen - curved - curva  
**AB 161-30** 30 cm / 12"



**Gefäßscheren**  
**Vascular Scissors**  
**Tijeras vasculares**



**Dietrich**

19 cm / 7½"

**AB 217-25** 25°

**AB 217-45** 45°

**AB 217-60** 60°

**AB 217-90** 90°

**AB 217-99** 125°



**Dietrich**

mit Führungsschiene  
with guiding bar  
con barra estabilizanda

18 cm / 7"

**AB 227-99** 125°

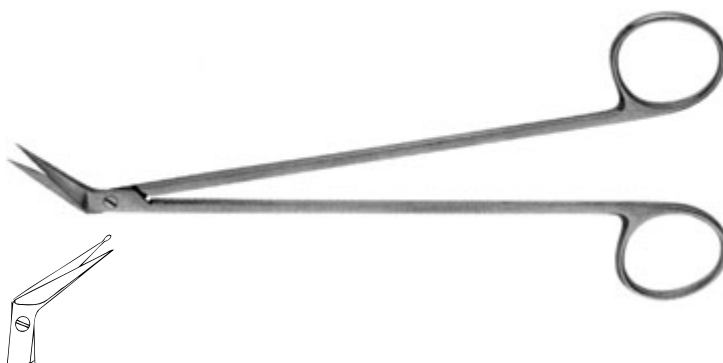

**Potts-Smith**

19 cm / 7½"

**AB 237-25** 25°

**AB 237-45** 45°

**AB 237-60** 60°

1 Blatt geknöpft

1 ball-tipped

1 hoja botonada

**AB 238-60** 60°



**AB 238-60**



**DeBakey**

16 cm / 6¼"

**AB 247-25** 25°

**AB 247-45** 45°

**AB 247-60** 60°

## Tenotomiescheren

## Tenotomy Scissors

## Tijeras para tenotomía



*gezahnt - serrated - dentada*

gerade - straight - recta

**AB 274-13** 13 cm / 5"

gebogen - curved - curva

**AB 275-13** 13 cm / 5"



### **Stevens**

stumpf/stumpf, gerade

blunt/blunt, straight

roma/roma, recta

**AB 300-11** 11 cm / 4¼"

gebogen - curved - curva

**AB 301-11** 11 cm / 4¼"



### **Stevens**

spitz/spitz, gerade

sharp/sharp, straight

aguda/aguda, recta

**AB 304-11** 11 cm / 4¼"

gebogen - curved - curva

**AB 305-11** 11 cm / 4¼"

**Knorpelschere, Fadenscheren**  
**Cartilage Scissors, Ligature Scissors**  
**Tijera para cartílago, tijeras para ligaduras**



**McIndoe**

Knorpelschere, *gezahnt*  
Cartilage scissors, *serrated*  
Tijera para cartílago, *dentada*

gerade - straight - recta  
**AB 354-19** 19 cm / 7½"



**Northbent**

Fadenschere  
Ligature scissors  
Tijera para ligaduras

**AB 407-13** 13 cm / 5"



**Buck**

Fadenscheren  
Ligature scissors  
Tijeras para ligaduras

**AB 410-14** 14 cm / 5½"  
**AB 410-18** 18 cm / 7"

**Fadenscheren, Drahtscheren**  
**Ligature Scissors, Wire Cutting Scissors**  
**Tijeras para ligaduras y alambres**



**Spencer**  
Fadenscheren  
Ligature scissors  
Tijeras para ligaduras

gerade - straight - recta  
**AB 417-09** 9 cm / 3½"

seitlich gebogen - curved to side - curva de lado  
**AB 419-09** 9 cm / 3½"

gerade - straight - recta  
**AB 427-13** 13 cm / 5"

seitlich gebogen - curved to side - curva de lado  
**AB 429-13** 13 cm / 5"



**Littauer**  
Fadenschere  
Ligature scissors  
Tijera para ligaduras

gerade - straight - recta  
**AB 437-14** 14 cm / 5½"



**Universal**  
gezahnt - serrated - dentada  
**AB 507-12** 12 cm / 4¾"

**Drahtscheren**  
**Wire Cutting Scissors**  
**Tijeras para alambres**



**Beebee**

*glatt - smooth - lisa*

stumpf/stumpf, gerade  
blunt/blunt, straight  
roma/roma, recta

**AB 510-10** 10 cm / 4"

**AB 510-12** 12 cm / 4¾"

gebogen - curved - curva

**AB 511-10** 10 cm / 4"

**AB 511-12** 12 cm / 4¾"



**Beebee**

*glatt - smooth - lisa*

spitz/spitz, gerade  
sharp/sharp, straight  
aguda/aguda, recta

**AB 514-10** 10 cm / 4"

**AB 514-12** 12 cm / 4¾"

gebogen - curved - curva

**AB 515-10** 10 cm / 4"

**AB 515-12** 12 cm / 4¾"



**Beebee**

*gezahnt - serrated - dentada*

spitz/spitz, gerade  
sharp/sharp, straight  
aguda/aguda, recta

**AB 516-10** 10 cm / 4"

**AB 516-12** 12 cm / 4¾"

gebogen - curved - curva

**AB 517-10** 10 cm / 4"

**AB 517-12** 12 cm / 4¾"

**Gynäkologische Scheren**  
**Gynecological Scissors**  
**Tijeras para ginecología**



**Mayo-Noble**

gerade - straight - recta

**AB 600-17** 17 cm / 6¾"

gebogen - curved - curva

**AB 601-17** 17 cm / 6¾"



**Sims**

stumpf/stumpf, gerade

blunt/blunt, straight

roma/roma, recta

**AB 610-20** 20 cm / 8"

**AB 610-23** 23 cm / 9"

gebogen - curved - curva

**AB 611-20** 20 cm / 8"

**AB 611-23** 23 cm / 9"



**Wertheim**

gebogen - curved - curva

**AB 621-14** 14,5 cm / 5¾"

**AB 621-19** 19,5 cm / 7¾"

**AB 621-22** 22,5 cm / 8¾"



**Doyen**

gerade - straight - recta

**AB 630-17** 17 cm / 6¾"

gebogen - curved - curva

**AB 631-17** 17 cm / 6¾"

**Gynäkologische Scheren**  
**Gynecological Scissors**  
**Tijeras para ginecología**



**Busch**

Nabelschnurschere, seitlich gebogen

Umbilical scissors, curved to side

Tijera umbilical, curva de lado

**AB 637-16** 16 cm / 6¼"



**Waldmann**

Episiotomieschere

Episiotomy scissors

Tijera para episiotomía

**AB 647-18** 18 cm / 7"



**Waldmann**

Episiotomieschere

Episiotomy scissors

Tijera para episiotomía

**AB 647-20** 20 cm / 8"

**Gynäkologische Scheren**  
**Gynecological Scissors**  
**Tijeras para ginecología**



**Braun-Stadler**

Episiotomiescheren

Episiotomy scissors

Tijeras para episiotomía

**AB 657-14** 14,5 cm / 5¾"

**AB 657-22** 22 cm / 8¾"



**Modell USA**

Nabelschnurschere

Umbilical scissors

Tijera umbilical

**AB 670-10** 10,5 cm / 4¼"



**Schumacher**

Nabelschnurschere

Umbilical scissors

Tijera umbilical

**AB 681-15** 15,5 cm / 6"



**Verband- und Gipsscheren**  
**Bandage Scissors and Plaster Shear**  
**Tijeras para vendajes y enyesados**



**Lister**

<b>AB 907-09</b>	9 cm / 3½"
<b>AB 907-11</b>	11 cm / 4¼"
<b>AB 907-14</b>	14 cm / 5½"
<b>AB 907-18</b>	18 cm / 7"
<b>AB 907-20</b>	20 cm / 8"



**Lister Excentric**

*gezahnt - serrated - dentada*  
**AB 909-19** 19 cm / 7½"



**Universal**

mit Plastikgriffen  
with plastic handles  
con mangos de plástico

<b>AB 917-15</b>	15 cm / 6"
<b>AB 917-18</b>	18 cm / 7"

**Verband- und Gipsscheren**  
**Bandage Scissors and Plaster Shear**  
**Tijeras para vendajes y enyesados**



**Lorenz**  
gebogen - curved - curva  
AB 921-23 23 cm / 9"



**Smith**  
Verbandschere  
Bandage scissors  
Tijera para vendajes  
AB 934-20 20 cm / 8"



**Bruns**  
Gipsschere, gezahnt  
Plaster shear, serrated  
Tijera para enyesados, dentada  
AB 957-24 24 cm / 9½"

**Verband- und Gipsscheren**  
**Bandage Scissors and Plaster Shear**  
**Tijeras para vendajes y enyesados**



**Bergmann**

kräftiges Modell – heavy pattern – modelo fuerte  
**AB 961-23** 23 cm / 9"



**Esmarch**

abgewinkelt – angled – angulada  
**AB 981-20** 20 cm / 8"  
**AB 981-22** 22 cm / 8¾"

## GOLD-CUT® plus

### Hartmetallscheren mit spezieller HIGH-TECH-Beschichtung



Rundkopfschraube hochglanz poliert  
High-finish polished buttonhead screw  
Tornillo de cabeza redonda abrigantada

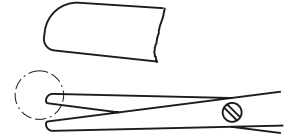

- Eine bis zu 4-5fach höhere Härte der Instrumentenoberfläche gewährleistet in Verbindung mit aufgeschweißten Hartmetallschneiden eine vielfach längere Standzeit der Schnitt- und Scherkanten. Daher deutlich resistenter gegen mechanische und chemische Beanspruchung!
- Die elektrophysikalische Glättung der Beschichtung gewährleistet eine optimale Gleitfähigkeit bei minimalem Abrieb und ist dank der glatten Oberfläche mühe- und rückstandslos zu reinigen!
- Sehr hohe Korrosions- und Rostbeständigkeit
- Die mattierte schwarzfarbige Oberfläche mit hochglänzender Rundkopfschraube ist ein besonderes Erkennungsmerkmal und ist darüber hinaus reflektionsarm im Operationsfeld.
- Gesteigerte Wirtschaftlichkeit, da sich die Lebensdauer des Instruments wesentlich erhöht und gleichzeitig den Wartungsaufwand minimiert.

## GOLD-CUT® plus

### Tungsten-Carbide scissors with special HIGH-TECH coating

- An instrument surface that is 4 to 5 times harder, combined with welded-on Tungsten-Carbide cutting edges, guarantees far longer life time for the cutting edges scissors edges. This makes the scissors far more resistant to mechanical and chemical stress!
- Electrophysical smoothing of the coating guarantees optimal glide quality and minimal friction wear, plus easy, residue-free cleaning thanks to the smooth surface!
- Very high levels of corrosion resistance and rust resistance
- The satin-finished, black surface with shiny buttonhead screws is a distinctive feature and also provides nonreflective property during operations.
- Increased economic efficiency, because the service life of the scissors has been significantly extended, and maintenance expenses correspondingly minimized.

## GOLD-CUT® plus

### Tijeras de metal duro con un revestimiento especial de ALTA TECNOLOGÍA

- Una mayor dureza, hasta 4 ó 5 veces más, de la superficie de los instrumentos, junto con hojas de metal duro soldado, garantiza una mayor duración de los bordes de corte y de cizallamiento, ofreciendo más resistencia a los esfuerzos mecánicos o químicos.
- El pulido electrofísico del revestimiento asegura un deslizamiento perfecto y un desgaste mínimo. ¡Gracias a la superficie lisa, las tijeras se limpian sin dificultad y sin dejar rastro de suciedad!
- Gran resistencia a la corrosión y oxidación
- El color negro mate de su superficie, junto con la cabeza redonda abrigantada, es un distintivo característico, que apenas produce reflejos en el campo de operaciones.
- Creciente rentabilidad debido a la mayor duración del instrumento y al menor mantenimiento.

**GOLD-CUT<sup>®</sup> plus HIGH-TECH-Scheren**

**GOLD-CUT<sup>®</sup> plus HIGH-TECH Scissors**

**GOLD-CUT<sup>®</sup> plus HIGH-TECH Tijeras**



**Mayo**

gerade - straight - recta

**AD 110-14** 14,5 cm / 5<sup>3</sup>/<sub>4</sub>"

gebogen - curved - curva

**AD 111-14** 14,5 cm / 5<sup>3</sup>/<sub>4</sub>"



**Mayo**

gerade - straight - recta

**AD 110-17** 17 cm / 6<sup>3</sup>/<sub>4</sub>"

gebogen - curved - curva

**AD 111-17** 17 cm / 6<sup>3</sup>/<sub>4</sub>"



**Mayo**

gerade - straight - recta

**AD 110-23** 23 cm / 9"

gebogen - curved - curva

**AD 111-23** 23 cm / 9"

**GOLD-CUT® plus HIGH-TECH-Scheren**

**GOLD-CUT® plus HIGH-TECH Scissors**

**GOLD-CUT® plus HIGH-TECH Tijeras**



**Lexer**

gerade - straight - recta

**AD 120-16** 16 cm / 6¼"

gebogen - curved - curva

**AD 121-16** 16 cm / 6¼"



**Mayo-Stille**

gerade - straight - recta

**AD 130-15** 15 cm / 6"

gebogen - curved - curva

**AD 131-15** 15 cm / 6"



**Mayo-Stille**

gerade - straight - recta

**AD 130-17** 17 cm / 6¾"

gebogen - curved - curva

**AD 131-17** 17 cm / 6¾"

**GOLD-CUT® plus HIGH-TECH-Scheren**

**GOLD-CUT® plus HIGH-TECH Scissors**

**GOLD-CUT® plus HIGH-TECH Tijeras**



**Metzenbaum**

gerade - straight - recta

**AD 150-18** 18 cm / 7"

gebogen - curved - curva

**AD 151-18** 18 cm / 7"



**Metzenbaum**

gerade - straight - recta

**AD 150-20** 20 cm / 8"

gebogen - curved - curva

**AD 151-20** 20 cm / 8"



**Metzenbaum**

gerade - straight - recta

**AD 150-23** 23 cm / 9"

gebogen - curved - curva

**AD 151-23** 23 cm / 9"

**GOLD-CUT® plus HIGH-TECH-Scheren**

**GOLD-CUT® plus HIGH-TECH Scissors**

**GOLD-CUT® plus HIGH-TECH Tijerass**



**Metzenbaum Fino**

gerade - straight - recta

**AD 160-14** 14,5 cm / 5<sup>3</sup>/<sub>4</sub>"

gebogen - curved - curva

**AD 161-14** 14,5 cm / 5<sup>3</sup>/<sub>4</sub>"



**Metzenbaum Fino**

gerade - straight - recta

**AD 160-18** 18 cm / 7"

gebogen - curved - curva

**AD 161-18** 18 cm / 7"

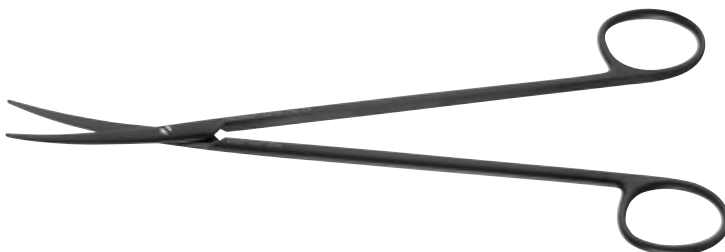

**Metzenbaum Fino**

gerade - straight - recta

**AD 160-20** 20 cm / 8"

gebogen - curved - curva

**AD 161-20** 20 cm / 8"



**GOLD-CUT® plus HIGH-TECH-Scheren**

**GOLD-CUT® plus HIGH-TECH Scissors**

**GOLD-CUT® plus HIGH-TECH Tijeras**



**Metzenbaum Baby**

gerade - straight - recta

**AD 200-11** 11,5 cm / 4½"

**AD 200-14** 14,5 cm / 5¾"

gebogen - curved - curva

**AD 201-11** 11,5 cm / 4½"

**AD 201-14** 14,5 cm / 5¾"



**Ragnell**

gezahnt - serrated - dentada

gebogen - curved - curva

**AD 229-11** 11,5 cm / 4½"



**Iris**

gerade - straight - recta

**AD 284-11** 11,5 cm / 4½"

gebogen - curved - curva

**AD 285-11** 11,5 cm / 4½"



**Toennis – Adson**

gebogen - curved - curva

**AD 251-17** 17 cm / 6¾"

## GOLD-CUT® *super*



Rundkopfschraube hochglanz vergoldet  
High-finish gold buttonhead screw  
Tornillo de cabeza redonda abrigantada  
y dorada

- Aufgeschweißte Hartmetallschneiden
- Vakuumgehärtet
- **Spezieller Schliff** am hinteren Blatt gewährleistet einen exzellenten Schnitt, insbesondere auch an der Spitze des Instruments
- Lange Lebensdauer

## GOLD-CUT® *super*

- Welded on tungsten-carbide cuttingedges
- Vacuum-hardened
- **Special grinding** of the rear blade guarantees a excellent cut, especially at the tip of the instrument
- Long life-time

## GOLD-CUT® *super*

- Tijeras de metal duro soldadas
- Endurecimiento al vacío
- **Pulido especial** en la hoja posterior que garantiza un corte preciso, también en la punta del instrumento
- Larga duración



**GOLD-CUT<sup>®</sup> super HIGH-TECH-Scheren**

**GOLD-CUT<sup>®</sup> super HIGH-TECH Scissors**

**GOLD-CUT<sup>®</sup> super HIGH-TECH Tijeras**



**Mayo-Style**

gerade - straight - recta

**AD 430-15** 15 cm / 6"

**AD 430-17** 17 cm / 6<sup>3</sup>/<sub>4</sub>"



**Mayo-Style**

gebogen - curved - curva

**AD 431-15** 15 cm / 6"

**AD 431-17** 17 cm / 6<sup>3</sup>/<sub>4</sub>"

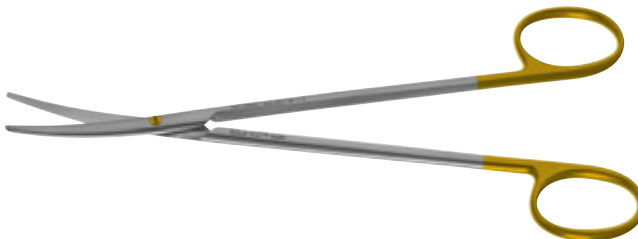

**Metzenbaum**

gebogen - curved - curva

**AD 451-14** 14,5 cm / 5<sup>3</sup>/<sub>4</sub>"

**AD 451-18** 18 cm / 7"

**AD 451-20** 20 cm / 8"

**AD 451-23** 23 cm / 9"



**Toennis – Adson**

gebogen - curved - curva

**AD 471-17** 17 cm / 6<sup>3</sup>/<sub>4</sub>"

### **GOLD-CUT® *super plus***

#### **Hartmetallscheren mit spezieller HIGH-TECH-Beschichtung**



Rundkopfschraube hochglanz vergoldet  
High-finish gold buttonhead screw  
Tornillo de cabeza redonda abrigantada  
y dorada

- Vereint die Vorteile der HIGH-TECH-Beschichtung der **GOLD-CUT® *plus***-Scheren und die hervorragenden Schnittleistungen der **GOLD-CUT® *super***-Scheren

### **GOLD-CUT® *super plus***

#### **Tungsten-carbide scissors with special HIGH-TECH coating**

- Combines the advantages of HIGH-TECH coating of the **GOLD-CUT® *plus*** scissors with the outstanding cut performance of the **GOLD-CUT® *super*** scissors.

### **GOLD-CUT® *super plus***

#### **Tijeras de metal duro con un revestimiento especial de ALTA TECNOLOGÍA**

- Aúna las ventajas del revestimiento de ALTA TECNOLOGÍA de las tijeras **GOLD-CUT®, *plus*** y los excelentes rendimientos de las tijeras **GOLD-CUT®, *super***.



**GOLD-CUT<sup>®</sup> *super plus* HIGH-TECH-Scheren**

**GOLD-CUT<sup>®</sup> *super plus* HIGH-TECH Scissors**

**GOLD-CUT<sup>®</sup> *super plus* HIGH-TECH Tijeras**



**Mayo-Stille**

gerade - straight - recta

**AD 330-15** 15 cm / 6"

gebogen - curved - curva

**AD 331-15** 15 cm / 6"



**Mayo-Stille**

gerade - straight - recta

**AD 330-17** 17 cm / 6<sup>3</sup>/<sub>4</sub>"

gebogen - curved - curva

**AD 331-17** 17 cm / 6<sup>3</sup>/<sub>4</sub>"



**Toennis – Adson**

gebogen - curved - curva

**AD 371-17** 17 cm / 6<sup>3</sup>/<sub>4</sub>"

**GOLD-CUT® *super plus* HIGH-TECH-Scheren**

**GOLD-CUT® *super plus* HIGH-TECH Scissors**

**GOLD-CUT® *super plus* HIGH-TECH Tijeras**



**Metzenbaum**

gebogen - curved - curva

**AD 351-14** 14,5 cm / 5 3/4"



**Metzenbaum**

gebogen - curved - curva

**AD 351-18** 18 cm / 7"



**Metzenbaum**

gebogen - curved - curva

**AD 351-20** 20 cm / 8"



**Metzenbaum**

gebogen - curved - curva

**AD 351-23** 23 cm / 9"

**GEOMED GOLD-CUT<sup>®</sup>**  
**Hartmetallscheren**

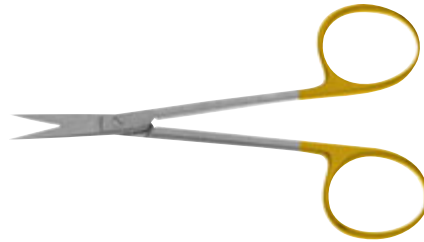

- aufgeschweißte Hartmetallschneiden
- vakuumgehärtet
- lange Schnittstandzeit durch modernste Bearbeitung

**GEOMED GOLD-CUT<sup>®</sup>**  
**Tungsten-Carbide Scissors**



- welded tungsten-carbide blades
- vacuum-hardened
- long-lasting cut through latest finishing know-how

**GEOMED GOLD-CUT<sup>®</sup>**  
**Tijeras con filos de carburo de tungsteno**

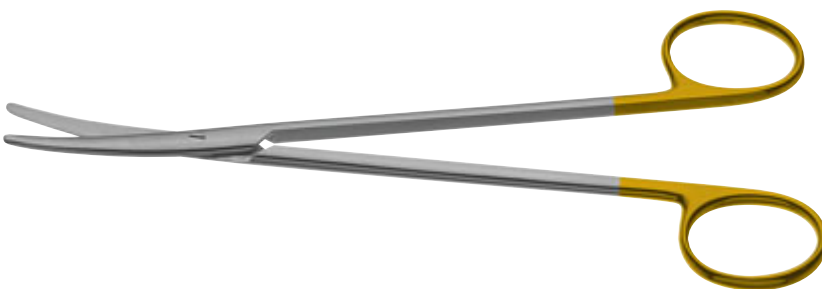

- Hojas de tungsteno soldadas
- templadas al vacío
- última tecnología garantiza larga duración del corte

**Präparierscheren**  
**Dissecting Scissors**  
**Tijeras de disección**

**GEOMED GOLD-CUT®**

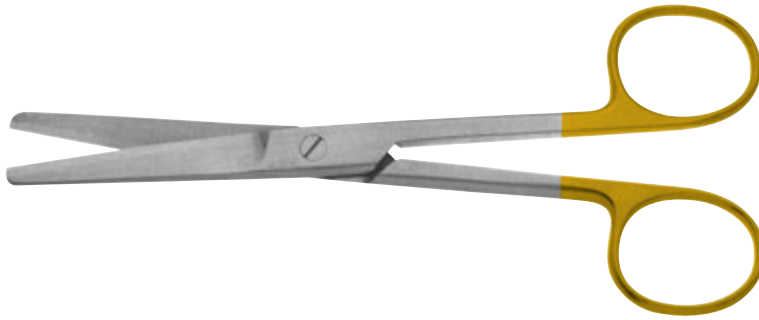

**Standard**

stumpf/stumpf, gerade

blunt/blunt, straight

roma/roma, recta

**AD 500-14** 14,5 cm / 5¾"

gebogen - curved - curva

**AD 501-14** 14,5 cm / 5¾"

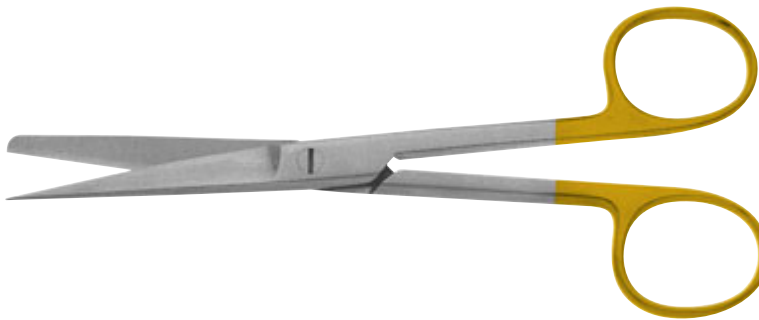

**Standard**

spitz/stumpf, gerade

sharp/blunt, straight

aguda/roma, recta

**AD 502-14** 14,5 cm / 5¾"

gebogen - curved - curva

**AD 503-14** 14,5 cm / 5¾"



**Standard**

spitz/spitz, gerade

sharp/sharp, straight

aguda/aguda, recta

**AD 504-14** 14,5 cm / 5¾"

gebogen - curved - curva

**AD 505-14** 14,5 cm / 5¾"





**Mayo**

gerade - straight - recta

**AD 510-14** 14,5 cm / 5<sup>3</sup>/<sub>4</sub>"

**AD 510-17** 17 cm / 6<sup>3</sup>/<sub>4</sub>"

**AD 510-23** 23 cm / 9"

gebogen - curved - curva

**AD 511-14** 14,5 cm / 5<sup>3</sup>/<sub>4</sub>"

**AD 511-17** 17 cm / 6<sup>3</sup>/<sub>4</sub>"

**AD 511-23** 23 cm / 9"

gezahnt - serrated - dentada

gerade - straight - recta

**AD 518-17** 17 cm / 6<sup>3</sup>/<sub>4</sub>"

gezahnt - serrated - dentada

gebogen - curved - curva

**AD 519-17** 17 cm / 6<sup>3</sup>/<sub>4</sub>"

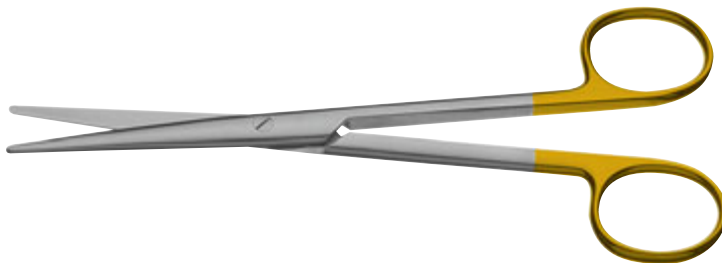

**Lexer**

gerade - straight - recta

**AD 520-16** 16 cm / 6<sup>1</sup>/<sub>4</sub>"

gebogen - curved - curva

**AD 521-16** 16 cm / 6<sup>1</sup>/<sub>4</sub>"

gezahnt - serrated - dentada

gebogen - curved - curva

**AD 529-16** 16 cm / 6<sup>1</sup>/<sub>4</sub>"

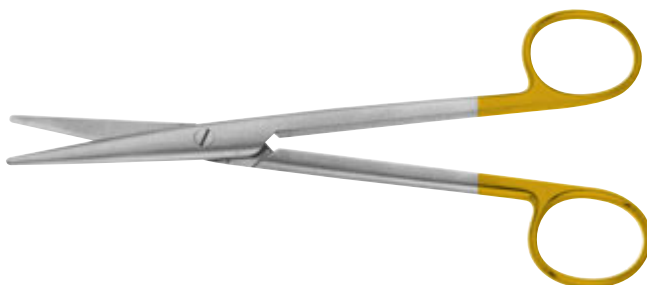

**Mayo-Stille**

gerade - straight - recta

**AD 530-15** 15 cm / 6"

**AD 530-16** 16 cm / 6<sup>1</sup>/<sub>4</sub>"

**AD 530-17** 17 cm / 6<sup>3</sup>/<sub>4</sub>"

gebogen - curved - curva

**AD 531-15** 15 cm / 6"

**AD 531-16** 16 cm / 6<sup>1</sup>/<sub>4</sub>"

**AD 531-17** 17 cm / 6<sup>3</sup>/<sub>4</sub>"

gezahnt - serrated - dentada

gerade - straight - recta

**AD 538-17** 17 cm / 6<sup>3</sup>/<sub>4</sub>"

gezahnt - serrated - dentada

gebogen - curved - curva

**AD 539-17** 17 cm / 6<sup>3</sup>/<sub>4</sub>"

**Präparierscheren**  
**Dissecting Scissors**  
**Tijeras de disección**

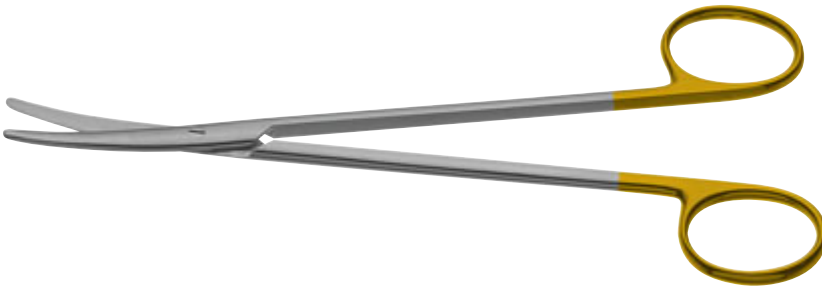

**Metzenbaum**

stumpf/stumpf, gerade  
blunt/blunt, straight  
roma/roma, recta

<b>AD 550-18</b>	18 cm / 7"
<b>AD 550-20</b>	20 cm / 8"
<b>AD 550-23</b>	23 cm / 9"
<b>AD 550-25</b>	25 cm / 10"

gebogen - curved - curva

<b>AD 551-18</b>	18 cm / 7"
<b>AD 551-20</b>	20 cm / 8"
<b>AD 551-23</b>	23 cm / 9"
<b>AD 551-25</b>	25 cm / 10"
<b>AD 551-28</b>	28 cm / 11"
<b>AD 551-30</b>	30 cm / 12"

*gezahnt - serrated - dentada*

gebogen - curved - curva

<b>AD 559-18</b>	18 cm / 7"
<b>AD 559-23</b>	23 cm / 9"
<b>AD 559-25</b>	25 cm / 10"

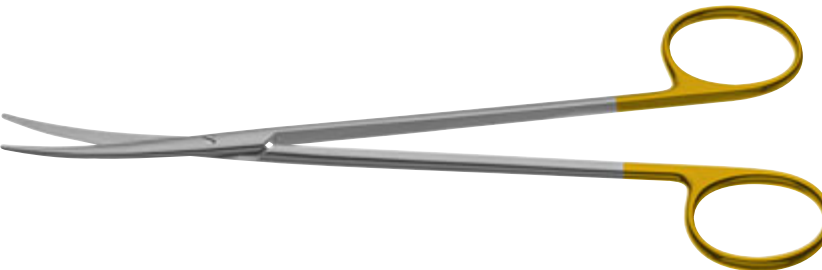

**Metzenbaum**

*feines Modell - fine pattern - modelo delgado*

stumpf/stumpf, gerade  
blunt/blunt, straight  
roma/roma, recta

<b>AD 560-14</b>	14,5 cm / 5¾"
<b>AD 560-18</b>	18 cm / 7"
<b>AD 560-20</b>	20 cm / 8"
<b>AD 560-23</b>	23 cm / 9"

gebogen - curved - curva

<b>AD 561-14</b>	14,5 cm / 5¾"
<b>AD 561-18</b>	18 cm / 7"
<b>AD 561-20</b>	20 cm / 8"
<b>AD 561-23</b>	23 cm / 9"
<b>AD 561-25</b>	25 cm / 10"
<b>AD 561-28</b>	28 cm / 11"

GEOMED GOLD-CUT®

Präparierscheren  
Dissecting Scissors  
Tijeras de disección



**Metzenbaum**

*feines Modell - fine pattern - modelo delgado*

*spitz/spitz, gerade  
sharp/sharp, straight  
aguda/aguda, recta*

**AD 564-14** 14,5 cm / 5¾"

**AD 564-18** 18 cm / 7"

**AD 564-23** 23 cm / 9"

*gebogen - curved - curva*

**AD 565-14** 14,5 cm / 5¾"

**AD 565-18** 18 cm / 7"

**AD 565-23** 23 cm / 9"



**Metzenbaum**

*gerade - straight - recta*

**AD 600-11** 11,5 cm / 4½"

**AD 600-14** 14,5 cm / 5¾"

*gebogen - curved - curva*

**AD 601-11** 11,5 cm / 4½"

**AD 601-14** 14,5 cm / 5¾"

*gezahnt - serrated - dentada*

*gebogen - curved - curva*

**AD 609-14** 14,5 cm / 5¾"



**Metzenbaum-Nelson**

*gerade - straight - recta*

**AD 614-25** 25 cm / 10"

**AD 614-28** 28 cm / 11"

**AD 614-30** 30 cm / 12"

*gebogen - curved - curva*

**AD 615-25** 25 cm / 10"

**AD 615-28** 28 cm / 11"

**AD 615-30** 30 cm / 12"

**Präparierscheren**  
**Dissecting Scissors**  
**Tijeras de disección**

**GEOMED GOLD-CUT®**

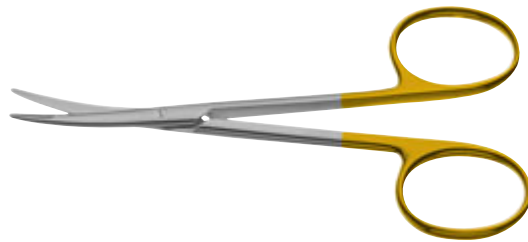

**Ragnell**  
gezahnt - serrated - dentada  
gebogen - curved - curva  
AD 629-12 12,5 cm / 5"



**Toennis-Adson**  
gebogen - curved - curva  
AD 651-17 17 cm / 6¾"



**Metzenbaum**  
stark gebogen - strong curve - curva fuerte  
AD 701-20 20 cm / 8"  
AD 701-23 23 cm / 9"  
AD 701-28 28 cm / 11"

GEOMED GOLD-CUT<sup>®</sup>

Gynäkologische Scheren  
Gynecological Scissors  
Tijeras para ginecología



Parametriumscheren  
Parametrium scissors  
Tijeras de parametrio

*leicht gebogen - light curved - curva ligera*  
AD 711-23 23 cm / 9"

*stark gebogen - strong curved - curva fuerte*  
AD 713-22 22 cm / 8<sup>3</sup>/<sub>4</sub>"

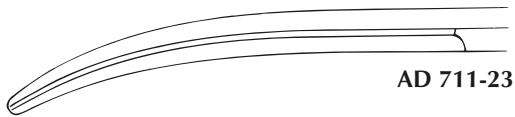

AD 711-23



AD 713-22



**Waldmann**  
Episiotomieschere  
Episiotomy Scissors  
Tijera para episiotomía  
AD 757-20 20 cm / 8"

**Feine Scheren, Drahtschere, Verbandschere**  
**Fine Scissors, Wire Cutting Scissors, Bandage Scissors**  
**Tijeras finas, tijeras para alambres y vendajes**

**GEOMED GOLD-CUT®**



**Kelly**

gerade - straight - recta  
**AD 774-16** 16 cm / 6¼"

gebogen - curved - curva  
**AD 775-16** 16 cm / 6¼"

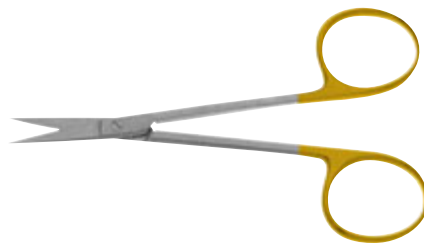

**Iris**

spitz/spitz, gerade  
sharp/sharp, straight  
aguda/aguda, recta  
**AD 784-11** 11,5 cm / 4½"

gebogen - curved - curva  
**AD 785-11** 11,5 cm / 4½"

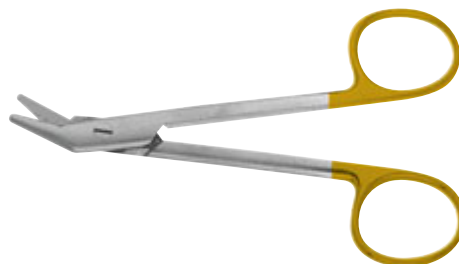

**Universal**

Drahtschere, *gezahnt*  
Wire cutting scissors, *serrated*  
Tijera para alambres, *dentada*  
**AD 810-12** 12,5 cm / 5"



**Lister**

Verbandschere  
Bandage scissors  
Tijera para vendajes  
**AD 813-18** 18 cm / 7"

GEOMED GOLD-CUT<sup>®</sup>

Gefäßscheren  
Vascular Scissors  
Tijeras vasculares

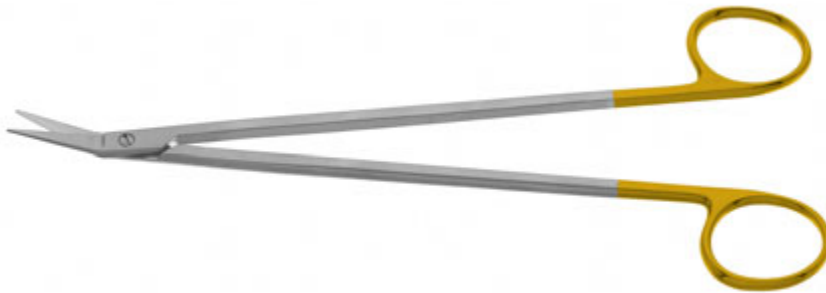

**Potts-Smith**  
19,0 cm / 7½"  
AD 815-25 25°  
AD 815-45 45°  
AD 815-60 60°

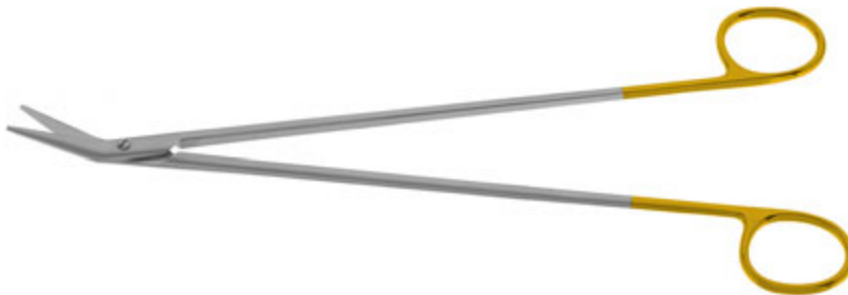

**DeBakey**  
17 cm / 6¾"  
AD 817-25 25°  
17 cm / 6¾"  
AD 817-45 45°  
17 cm / 6¾"  
AD 817-60 60°

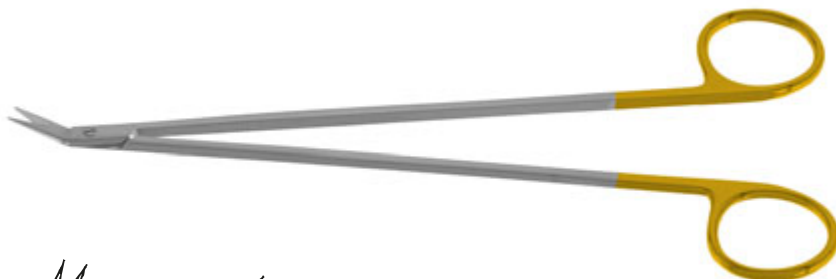

**Hegemann-Diethrich**  
18 cm / 7"  
AD 821-25 25°  
AD 821-45 45°  
17,5 cm / 7"  
AD 821-60 60°  
17 cm / 6¾"  
AD 821-90 90°  
AD 821-99 125°

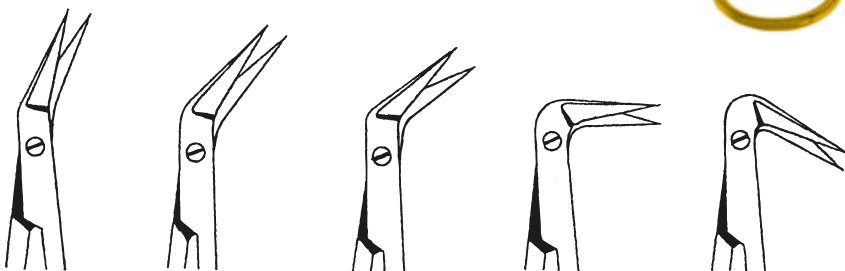

25°

45°

60°

90°

125°

**Abgewinkelte Scheren, Tenotomiescheren**  
**Angled Scissors, Tenotomy Scissors**  
**Tijeras anguladas, Tijeras para tenotomía**

**GEOMED GOLD-CUT®**



**Locklin**  
gebogene Branchen, *gezahnt*  
curved handles, *serrated*  
mangos curvos, *dentada*  
**AD 825-16** 16 cm / 6¼"



**Locklin**  
gerade Branchen, *gezahnt*  
straight handles, *serrated*  
mangos rectos, *dentada*  
**AD 835-16** 16 cm / 6¼"



Tenotomiescheren, *gezahnt*  
Tenotomy scissors, *serrated*  
Tijeras para tenotomía, *dentada*

gerade - straight - recta  
**AD 840-13** 13 cm / 5"

gebogen - curved - curva  
**AD 841-13** 13 cm / 5"



**Anatomische Pinzetten**  
**Dressing Forceps**  
**Pinzas de disección sin dientes**



**Standard**

AE 100-10	10,5 cm / 4¼"
AE 100-11	11,5 cm / 4½"
AE 100-13	13 cm / 5"
AE 100-14	14,5 cm / 5¾"
AE 100-16	16 cm / 6¼"
AE 100-18	18 cm / 7"
AE 100-20	20 cm / 8"
AE 100-25	25 cm / 10"
AE 100-30	30 cm / 12"



**Standard**

*mittelbreit - medium wide - anchura media*

AE 110-11	11,5 cm / 4½"
AE 110-13	13 cm / 5"
AE 110-14	14,5 cm / 5¾"
AE 110-16	16 cm / 6¼"
AE 110-18	18 cm / 7"
AE 110-20	20 cm / 8"
AE 110-25	25 cm / 10"
AE 110-30	30 cm / 12"



**Standard**

*fein - fine - fina*

AE 120-11	11,5 cm / 4½"
AE 120-13	13 cm / 5"
AE 120-14	14,5 cm / 5¾"
AE 120-16	16 cm / 6¼"
AE 120-18	18 cm / 7"
AE 120-20	20 cm / 8"
AE 120-25	25 cm / 10"
AE 120-30	30 cm / 12"



**USA Standard**

AE 140-14	14,5 cm / 5¾"
AE 140-18	18 cm / 7"
AE 140-20	20 cm / 8"

**Anatomische Pinzetten**  
**Dressing Forceps**  
**Pinzas de disección sin dientes**



**Adson**  
 AE 160-12 12 cm / 4¾"  
 AE 160-15 15 cm / 6"



**Micro-Adson**  
 AE 170-12 12 cm / 4¾"  
 AE 170-15 15 cm / 6"



**Gerald**  
 gerade - straight - recta  
 AE 180-18 18 cm / 7"

gebogen - curved - curva  
 AE 181-18 18 cm / 7"



**Semken**  
 AE 200-12 12,5 cm / 5"  
 AE 200-15 15 cm / 6"



**Taylor**  
 mit Schaberende  
 with dissector end  
 con cabo disecador  
 AE 224-17 17,5 cm / 7"  
 AE 224-18 18,5 cm / 7¼"

**Anatomische Pinzetten**  
**Dressing Forceps**  
**Pinzas de disección sin dientes**



**McIndoe**  
**AE 230-15** 15 cm / 6"



**Potts-Smith**  
**AE 250-18** 18 cm / 7"  
**AE 250-21** 21 cm / 8¼"  
**AE 250-25** 25 cm / 10"



**Iris**  
gerade - straight - curva  
**AE 270-10** 10 cm / 4"



**AE 270-10**



**AE 271-10**



**AE 273-10**

leicht gebogen - light curved - curva ligera  
**AE 271-10** 10 cm / 4"

stark gebogen - strong curved - curva fuerte  
**AE 273-10** 10 cm / 4"



**Cushing**  
gerade - straight - recta  
**AE 280-17** 17,5 cm / 6¾"

gebogen - curved - curva  
**AE 281-17** 17,5 cm / 6¾"

**Anatomische Pinzetten**  
**Dressing Forceps**  
**Pinzas de disección sin dientes**



**Wangensteen**  
 AE 290-15 15 cm / 6"  
 AE 290-23 23 cm / 9"  
 AE 290-30 30 cm / 12"



**Waugh**  
 AE 300-20 20 cm / 8"

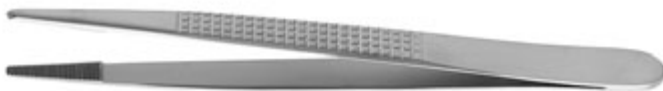

**Bonney**  
 AE 310-17 17,5 cm / 6¾"



**Brophy**  
 gerade - straight - recta  
 AE 320-20 20 cm / 8"

gebogen - curved - curva  
 AE 321-20 20 cm / 8"



**Ramsey**  
 AE 330-18 18 cm / 7"

**Chirurgische Pinzetten**  
**Tissue Forceps**  
**Pinzas de disección con dientes**



**Standard**

1 x 2 Zähne - 1 x 2 teeth - 1 x 2 dientes

**AE 406-10** 10,5 cm / 4"

**AE 406-11** 11,5 cm / 4½"

**AE 406-13** 13 cm / 5"

**AE 406-14** 14,5 cm / 5¾"

**AE 406-16** 16 cm / 6¼"

**AE 406-18** 18 cm / 7"

**AE 406-20** 20 cm / 8"

**AE 406-25** 25 cm / 10"

**AE 406-30** 30 cm / 12"



**Standard**

*mittelbreit - medium wide - anchura media*

1 x 2 Zähne - 1 x 2 teeth - 1 x 2 dientes

**AE 416-11** 11,5 cm / 4½"

**AE 416-13** 13 cm / 5"

**AE 416-14** 14,5 cm / 5¾"

**AE 416-16** 16 cm / 6¼"

**AE 416-18** 18 cm / 7"

**AE 416-20** 20 cm / 8"



**Standard**

*fein - fine - fina*

1 x 2 Zähne - 1 x 2 teeth - 1 x 2 dientes

**AE 426-13** 13 cm / 5"

**AE 426-14** 14,5 cm / 5¾"

**AE 426-16** 16 cm / 6¼"

**AE 426-18** 18 cm / 7"

**AE 426-20** 20 cm / 8"



**Standard**

2 x 3 Zähne - 2 x 3 teeth - 2 x 3 dientes

**AE 436-14** 14,5 cm / 5¾"

**AE 436-16** 16 cm / 6¼"

**AE 436-18** 18 cm / 7"

## Chirurgische Pinzetten

### Tissue Forceps

### Pinzas de disección con dientes



#### USA Standard

1 x 2 Zähne - 1 x 2 teeth - 1 x 2 dientes

AE 456-14 14,5 cm / 5¾"

AE 456-18 18 cm / 7"

AE 456-20 20 cm / 8"



#### Semken

1 x 2 Zähne - 1 x 2 teeth - 1 x 2 dientes

AE 466-12 12,5 cm / 5"

AE 466-15 15 cm / 6"



#### Gillies

1 x 2 Zähne - 1 x 2 teeth - 1 x 2 dientes

AE 476-15 15 cm / 6"



#### Adson

1 x 2 Zähne - 1 x 2 teeth - 1 x 2 dientes

AE 486-12 12 cm / 4¾"

AE 486-15 15 cm / 6"



#### Micro-Adson

1 x 2 Zähne - 1 x 2 teeth - 1 x 2 dientes

AE 496-12 12 cm / 4¾"

AE 496-15 15 cm / 6"

**Chirurgische Pinzetten**  
**Tissue Forceps**  
**Pinzas de disección con dientes**



**Adson**

*kariert - cross serrated - estrias cruzadas*

1 x 2 Zähne - 1 x 2 teeth - 1 x 2 dientes

**AE 506-12** 12 cm / 4¾"



**Adson-Brown**

9 x 9 Zähne - 9 x 9 teeth - 9 x 9 dientes

**AE 536-12** 12 cm / 4¾"



**Taylor**

*mit Schaberende*

*with dissector end*

*con cabo disecador*

1 x 2 Zähne - 1 x 2 teeth - 1 x 2 dientes

**AE 538-18** 18,5 cm / 7¼"



**Stille**

1 x 2 Zähne - 1 x 2 teeth - 1 x 2 dientes

**AE 546-15** 15 cm / 6"



**Gerald**

1 x 2 Zähne - 1 x 2 teeth - 1 x 2 dientes

*gerade - straight - recta*

**AE 556-17** 17,5 cm / 7"

*gebogen - curved - curva*

**AE 557-17** 17,5 cm / 7"

**Chirurgische Pinzetten**  
**Tissue Forceps**  
**Pinzas de disección con dientes**



**Potts-Smith**

1 x 2 Zähne - 1 x 2 teeth - 1 x 2 dientes  
**AE 566-18** 18 cm / 7"  
**AE 566-21** 21 cm / 8¼"  
**AE 566-25** 25 cm / 10"



**Cushing**

1 x 2 Zähne - 1 x 2 teeth - 1 x 2 dientes  
**AE 576-17** 17,5 cm / 6¾"



**Iris**

1 x 2 Zähne - 1 x 2 teeth - 1 x 2 dientes

gerade - straight - recta

**AE 586-10** 10 cm / 4"

leicht gebogen - light curved - curva ligera

**AE 587-10** 10 cm / 4"

stark gebogen - strong curved - curva fuerte

**AE 589-10** 10 cm / 4"



**Adlerkreutz**

2 x 3 Zähne - 2 x 3 teeth - 2 x 3 dientes  
**AE 606-15** 15 cm / 6"  
**AE 606-20** 20 cm / 8"



**Adlerkreutz**

4 x 5 Zähne - 4 x 5 teeth - 4 x 5 dientes  
**AE 616-15** 15 cm / 6"  
**AE 616-20** 20 cm / 8"  
**AE 616-25** 25 cm / 10"



**Chirurgische Pinzetten**  
**Tissue Forceps**  
**Pinzas de disección con dientes**



**McIndoe**

1 x 2 Zähne - 1 x 2 teeth - 1 x 2 dientes  
AE 626-15 15 cm / 6"



**Waugh**

1 x 2 Zähne - 1 x 2 teeth - 1 x 2 dientes  
AE 646-20 20 cm / 8"



**Lane**

1 x 2 Zähne - 1 x 2 teeth - 1 x 2 dientes  
AE 656-15 15 cm / 6"



**Barraya**

3 x 4 Zähne - 3 x 4 teeth - 3 x 4 dientes  
AE 686-18 18 cm / 7"  
AE 686-20 20 cm / 8"  
AE 686-25 25 cm / 10"

## Chirurgische Pinzetten

### Tissue Forceps

### Pinzas de disección con dientes



**Bonney**

1 x 2 Zähne - 1 x 2 teeth - 1 x 2 dientes  
AE 691-18 18 cm / 7"



**Nelson**

6 x 7 Zähne - 6 x 7 teeth - 6 x 7 dientes  
AE 720-23 23 cm / 9"



**Brown**

9 x 9 Zähne - 9 x 9 teeth - 9 x 9 dientes  
AE 736-15 15 cm / 6"  
AE 736-20 20 cm / 8"  
AE 736-25 25 cm / 10"



**Russian**

AE 806-15 15 cm / 6"  
AE 806-20 20 cm / 8"  
AE 806-25 25 cm / 10"

**Gewebe- und Tumorfasspinzetten**  
**Tissue and Tumor Grasping Forceps**  
**Pinzas de agarre para tejido y tumor**



**Mayo-Russian**  
AE 816-23 23 cm / 9"



**Singley-Tuttle**  
AE 830-23 23 cm / 9"

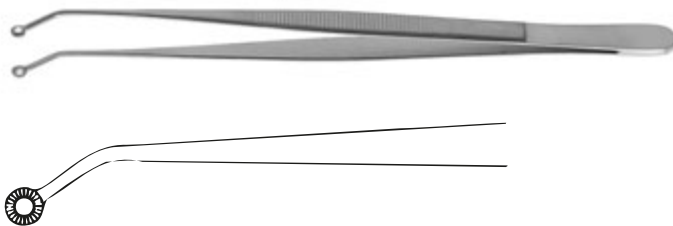

**Hunt**  
Ø 5mm  
gerieft – serrated - estriada  
AE 841-20 20 cm / 8"

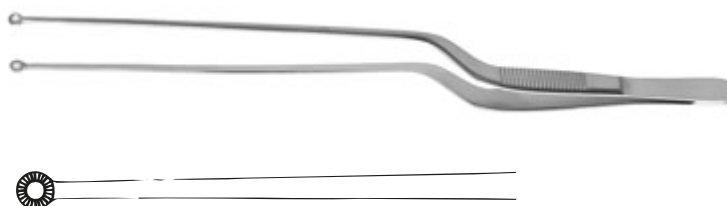

Ø 5mm  
gerieft – serrated - estriada  
AE 842-22 22 cm / 8¾"

**Gewebefasspinzetten**  
**Tissue Grasping Forceps**  
**Pinzas de agarre para tejido**



**Duval**  
Breite - width - anchura 10 mm  
**AE 866-14** 14 cm / 5½"



**Collin-Duval**  
Breite - width - anchura 15 mm  
**AE 876-20** 20 cm / 8"

Breite - width - anchura 20 mm  
**AE 886-20** 20 cm / 8"

Breite - width - anchura 26 mm  
**AE 896-20** 20 cm / 8"

**Zilienpinzette, Splitterpinzette, Splitterzangen**  
**Cilia Forceps, Splinter Forceps**  
**Pinzas para ciliias, pinzas para espiñas**



**Littauer**

Zilienpinzette

Cilia forceps

Pinza para ciliias

**AF 100-08** 8,5 cm / 3¼"



Zilienpinzette

Cilia forceps

Pinza para ciliias

**AF 105-09** 9 cm / 3½"



**Feilchenfeld**

Splitterpinzetten

Splinter forceps

Pinzas para espiñas

**AF 140-07** 7,5 cm / 3"

**AF 140-09** 9 cm / 3½"

**AF 140-11** 11 cm / 4½"

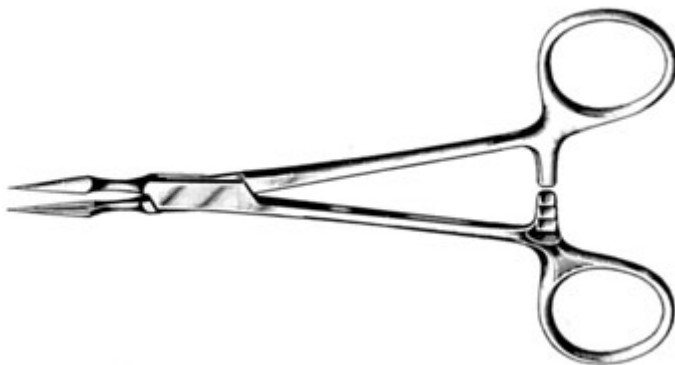

**Stieglitz**

gerade - straight - recta

**AF 160-13** 13,5 cm / 5¼"

gebogen - curved - curva

**AF 161-13** 13,5 cm / 5¼"



Splitterpinzetten, gerade

Splinter forceps, straight

Pinzas para espiñas, recta

**AF 170-09** 9 cm / 3½"

**AF 170-10** 10,5 cm / 4¼"

**AF 170-11** 11,5 cm / 4½"

**AF 170-12** 12,5 cm / 5"

gebogen - curved - curva

**AF 171-09** 9 cm / 3½"

**AF 171-10** 10,5 cm / 4¼"

**AF 171-11** 11,5 cm / 4½"

**AF 171-12** 12,5 cm / 5"

**Mikroskopierpinzetten (Juwelierpinzetten)**

**Microscopic Forceps (Jeweler's Forceps)**

**Pinzas para microscopía (pinzas de joyero)**



# 3  
AF 183-11 11,5 cm / 4½"



# 4  
AF 184-11 11 cm / 4¼"



# 5  
AF 185-11 11 cm / 4¼"



# 7  
AF 187-11 11,5 cm / 4½"

**Ohr- und Nasenpinzetten**  
**Ear and Nasal Dressing Forceps**  
**Pinzas auriculares y nasales**



**Grünwald**  
AF 515-20 20 cm / 8"



**Jansen**  
AF 525-16 16 cm / 6¼"  
AF 525-20 20 cm / 8"



**Lucae**  
AF 535-14 14 cm / 5½"



**Trölsch (Wilde)**  
AF 551-13 13 cm / 5"  
AF 551-15 15 cm / 6"  
AF 551-18 18 cm / 7"



**Trölsch (Wilde)**  
*feines Modell - fine pattern - modelo delgado*  
AF 561-11 11 cm / 4½"

**Hautfaspinzette, Columellapinzetten, Zahnpinzetten**  
**Skin frasping Forceps, Columella Forceps, Tweezers**  
**Pinza para piel, para columella y para algodón y curaciones**



**Cottle**  
mit Zähnnchen – with teeth – con dientes  
**AF 585-14** 14 cm / 5½"



**Cottle**  
Columellapinzette  
Columella Forceps  
Pinza para columella  
**AF 590-11** 11 cm / 4¼"



**Meriam**  
16 cm / 6¼"  
**AF 603-01** # 1  
**AF 603-02** # 2  
**AF 603-03** # 3  
**AF 603-04** # 4  
**AF 603-05** # 5  
**AF 603-06** # 6

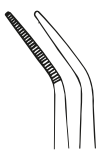

**AF 603-01**

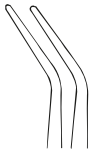

**AF 603-02**

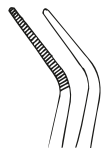

**AF 603-03**



**AF 603-04**

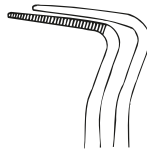

**AF 603-05**

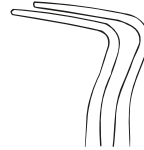

**AF 603-06**



**London-College**  
15 cm / 6"  
**AF 611-01** # 1  
**AF 611-02** # 2  
**AF 611-03** # 3  
**AF 611-04** # 4  
**AF 611-05** # 5  
**AF 611-06** # 6

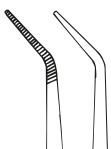

**AF 611-01**



**AF 611-02**

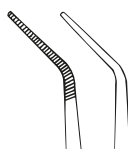

**AF 611-03**

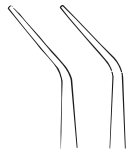

**AF 611-04**

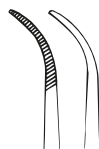

**AF 611-05**

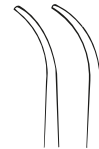

**AF 611-06**





DeBakey-Zahnung  
DeBakey serration  
Bocas tipo DeBakey

## Atraumatische Gefäßpinzetten Atraumatic Dissecting Forceps Pinzas de disección atraumáticas



1/1



1/1



1/1



1/1



1/1

### DeBakey

Breite - width - anchura 1,5 mm  
gerade - straight - recta

<b>AF 800-16</b>	16 cm / 6¼"
<b>AF 800-20</b>	20 cm / 8"
<b>AF 800-24</b>	24 cm / 9½"
<b>AF 800-30</b>	30 cm / 12"

### DeBakey

Breite - width - anchura 2,0 mm  
gerade - straight - recta

<b>AF 810-16</b>	16 cm / 6¼"
<b>AF 810-20</b>	20 cm / 8"
<b>AF 810-24</b>	24 cm / 9½"
<b>AF 810-30</b>	30 cm / 12"

### DeBakey

Breite - width - anchura 2,0 mm  
abgewinkelt - angled to side - angulada

<b>AF 811-16</b>	16 cm / 6¼"
<b>AF 811-20</b>	20 cm / 8"
<b>AF 811-24</b>	24 cm / 9½"
<b>AF 811-30</b>	30 cm / 12"

### DeBakey

Breite - width - anchura 2,7 mm  
gerade - straight - recta

<b>AF 830-16</b>	16 cm / 6¼"
<b>AF 830-20</b>	20 cm / 8"
<b>AF 830-24</b>	24 cm / 9½"
<b>AF 830-30</b>	30 cm / 12"

### DeBakey

Breite - width - anchura 3,5 mm  
gerade - straight - recta

<b>AF 840-16</b>	16 cm / 6¼"
<b>AF 840-20</b>	20 cm / 8"
<b>AF 840-24</b>	24 cm / 9½"
<b>AF 840-30</b>	30 cm / 12"

**Chirurgische und anatomische Pinzetten**  
**Dressing and Tissue Forceps**  
**Pinzas de disección con y sin dientes**



- Standard**  
**AH 090-13** 13 cm / 5"  
**AH 090-14** 14,5 cm / 5¾"  
**AH 090-16** 16 cm / 6¼"  
**AH 090-18** 18 cm / 7"  
**AH 090-20** 20 cm / 8"  
**AH 090-25** 25 cm / 10"



- Potts-Smith**  
 mit Schaberende  
 with dissector end  
 con cabo disecador  
**AH 100-15** 15 cm / 6"  
**AH 100-18** 18 cm / 7"  
**AH 100-20** 20 cm / 8"



- Cushing**  
 mit Schaberende  
 with dissector end  
 con cabo disecador
- gerade - straight - recta  
**AH 170-17** 17,5 cm / 7"
- abgewinkelt - angled to side - angulada  
**AH 171-17** 17,5 cm / 7"

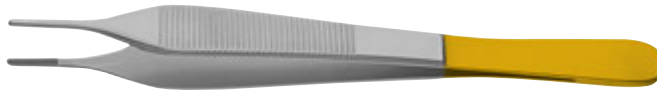

- Adson**  
**AH 420-12** 12 cm / 4¾"  
**AH 420-15** 15 cm / 6"
- 1 x 2 Zähne - 1 x 2 teeth - 1 x 2 dientes  
**AH 426-12** 12 cm / 4¾"  
**AH 426-15** 15 cm / 6"



- Micro-Adson**  
**AH 430-12** 12 cm / 4¾"  
**AH 430-15** 15 cm / 6"
- 1 x 2 Zähne - 1 x 2 teeth - 1 x 2 dientes  
**AH 436-12** 12 cm / 4¾"  
**AH 436-15** 15 cm / 6"

GEOMED GOLD-GRIP<sup>®</sup>

Chirurgische und atraumatische Pinzetten  
Tissue and Atraumatic Forceps  
Pinzas de disección, Pinzas de atraumáticas



**Öhler**

1 x 2 Zähne - 1 x 2 teeth - 1 x 2 dientes

AH 506-14 14 cm / 5½"

AH 506-16 16 cm / 6½"



**DeBakey-Zahnung**  
**DeBakey serration**  
**Bocas tipo DeBakey**



**DeBakey**

Nadelhalterpinzette, 6 x 12 Zähne

Needle-pulling forceps, 6 x 12 teeth

Pinza de porta-agujas, 6 x 12 dientes

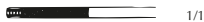

Breite - width - anchura 1,5 mm

AH 606-15 15 cm / 6"

AH 606-19 19 cm / 7½"



Breite - width - anchura 2,0 mm

AH 616-15 15 cm / 6"

AH 616-19 19 cm / 7½"

AH 616-24 24 cm / 9½"



Breite - width - anchura 2,7 mm

AH 636-15 15 cm / 6"

AH 636-19 19 cm / 7½"

AH 636-24 24 cm / 9½"



Breite - width - anchura 3,5 mm

AH 646-19 19 cm / 7½"

AH 646-24 24 cm / 9½"

**Bulldogklemmen**  
**Bulldog Clamps**  
**Pinzas bulldog**



AI 010-03



AI 010-05



AI 010-06



AI 011-03



AI 011-05



AI 011-06



AI 020-08

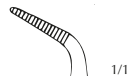

AI 021-08



AI 022-12

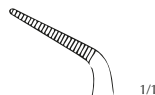

AI 023-12

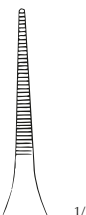

AI 024-20

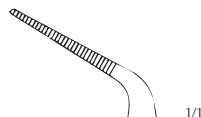

AI 025-20

**Dieffenbach**

gerade - straight - recta

AI 010-03 3,5 cm / 1½"

AI 010-05 5 cm / 2"

AI 010-06 6 cm / 2½"

gebogen - curved - curva

AI 011-03 3,5 cm / 1½"

AI 011-05 5 cm / 2"

AI 011-06 6 cm / 2½"

**Dietrich**

Maul - jaw - boca 8 mm

Gewicht - weight - peso 3 g

Druck - pressure - presión 50 g

gerade - straight - recta

AI 020-08 5 cm / 2"

abgewinkelt - angled - angulada

AI 021-08 5 cm / 2"

Maul - jaw - boca 12 mm

Gewicht - weight - peso 5 g

Druck - pressure - presión 50 g

gerade - straight - recta

AI 022-12 5,5 cm / 2¼"

abgewinkelt - angled - angulada

AI 023-12 5,5 cm / 2¼"

Maul - jaw - boca 20 mm

Gewicht - weight - peso 6 g

Druck - pressure - presión 50 g

gerade - straight - recta

AI 024-20 6 cm / 2½"

abgewinkelt - angled - angulada

AI 025-20 6 cm / 2½"

**Bulldogklemmen**  
**Bulldog Clamps**  
**Pinzas bulldog**



**Johns-Hopkins**

gerade – straight - recta

<b>AI 030-40</b>	4 cm / 1½"
<b>AI 030-50</b>	5 cm / 2"
<b>AI 030-60</b>	6 cm / 2¼"
<b>AI 030-65</b>	6,5 cm / 2½"
<b>AI 030-70</b>	7 cm / 2¾"
<b>AI 030-75</b>	7,5 cm / 3"
<b>AI 030-90</b>	9,0 cm / 3½"



gebogen – curved - curva

<b>AI 031-40</b>	4 cm / 1½"
<b>AI 031-50</b>	5 cm / 2"
<b>AI 031-60</b>	6 cm / 2¼"
<b>AI 031-65</b>	6,5 cm / 2½"
<b>AI 031-70</b>	7 cm / 2¾"
<b>AI 031-75</b>	7,5 cm / 3"
<b>AI 031-90</b>	9 cm / 3½"

**Clip Anlegezangen, Seite L.25**  
**Clip applying forceps, page L.25**  
**Pinzas para aplicar clips, pagina L.25**

**Arterienklemmen**  
**Hemostatic Forceps**  
**Pinzas hemostáticas**



**Hartmann (Baby-Mosquito)**

gerade - straight - recta

**AI 080-10** 10 cm / 4"

gebogen - curved - curva

**AI 081-10** 10 cm / 4"

1 x 2 Zähne - 1 x 2 teeth - 1 x 2 dientes

gerade - straight - recta

**AI 086-10** 10 cm / 4"

1 x 2 Zähne - 1 x 2 teeth - 1 x 2 dientes

gebogen - curved - curva

**AI 087-10** 10 cm / 4"



**Micro-Mosquito**

gerade - straight - recta

**AI 090-10** 10 cm / 4"

**AI 090-12** 12 cm / 4¾"

gebogen - curved - curva

**AI 091-10** 10 cm / 4"

**AI 091-12** 12 cm / 4¾"

1 x 2 Zähne - 1 x 2 teeth - 1 x 2 dientes

gerade - straight - recta

**AI 096-10** 10 cm / 4"

**AI 096-12** 12 cm / 4¾"

1 x 2 Zähne - 1 x 2 teeth - 1 x 2 dientes

gebogen - curved - curva

**AI 097-10** 10 cm / 4"

**AI 097-12** 12 cm / 4¾"

**Arterienklemmen**  
**Hemostatic Forceps**  
**Pinzas hemostáticas**



**Halstead-Mosquito**

gerade - straight - recta

**AI 100-12** 12,5 cm / 5"

**AI 100-14** 14 cm / 5½"

gebogen - curved - curva

**AI 101-12** 12,5 cm / 5"

**AI 101-14** 14 cm / 5½"

1 x 2 Zähne - 1 x 2 teeth - 1 x 2 dientes

gerade - straight - recta

**AI 106-12** 12,5 cm / 5"

**AI 106-14** 14 cm / 5½"

1 x 2 Zähne - 1 x 2 teeth - 1 x 2 dientes

gebogen - curved - curva

**AI 107-12** 12,5 cm / 5"

**AI 107-14** 14 cm / 5½"



**Halstead**

gerade - straight - recta

**AI 110-18** 18 cm / 7"

**AI 110-21** 21 cm / 8¼"

gebogen - curved - curva

**AI 111-18** 18 cm / 7"

**AI 111-21** 21 cm / 8¼"

1 x 2 Zähne - 1 x 2 teeth - 1 x 2 dientes

gerade - straight - recta

**AI 116-18** 18 cm / 7"

**AI 116-21** 21 cm / 8¼"

1 x 2 Zähne - 1 x 2 teeth - 1 x 2 dientes

gebogen - curved - curva

**AI 117-18** 18 cm / 7"

**AI 117-21** 21 cm / 8¼"

**Arterienklemmen**  
**Hemostatic Forceps**  
**Pinzas hemostáticas**



**Leriche**

gerade - straight - recta

**AI 120-15** 15 cm / 6"

gebogen - curved - curva

**AI 121-15** 15 cm / 6"

1 x 2 Zähne - 1 x 2 teeth - 1 x 2 dientes

gerade - straight - recta

**AI 126-15** 15 cm / 6"

1 x 2 Zähne - 1 x 2 teeth - 1 x 2 dientes

gebogen - curved - curva

**AI 127-15** 15 cm / 6"



**Crile**

gerade - straight - recta

**AI 130-14** 14 cm / 5½"

gebogen - curved - curva

**AI 131-14** 14 cm / 5½"

1 x 2 Zähne - 1 x 2 teeth - 1 x 2 dientes

gerade - straight - recta

**AI 136-14** 14 cm / 5½"



1 x 2 Zähne - 1 x 2 teeth - 1 x 2 dientes

gebogen - curved - curva

**AI 137-14** 14 cm / 5½"



**Rankin-Crile**

gerade - straight - recta

**AI 140-16** 16 cm / 6¼"

gebogen - curved - curva

**AI 141-16** 16 cm / 6¼"



**Arterienklemmen**  
**Hemostatic Forceps**  
**Pinzas hemostáticas**

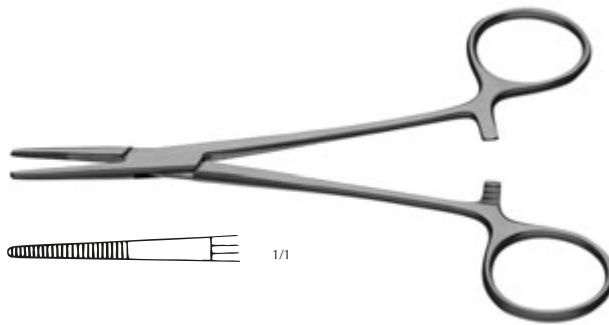

**Providence-Hospital**

gerade - straight - recta

**AI 150-14** 14 cm / 5½"

gebogen - curved - curva

**AI 151-14** 14 cm / 5½"



1/1

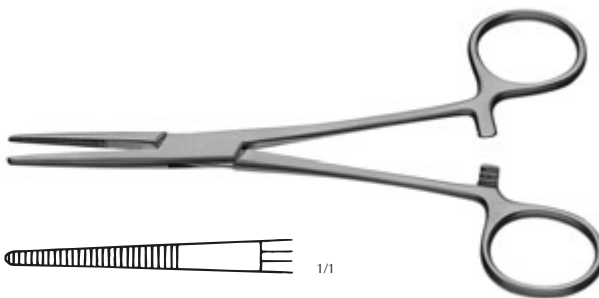

**Kelly**

gerade - straight - recta

**AI 160-14** 14 cm / 5½"

gebogen - curved - curva

**AI 161-14** 14 cm / 5½"



1/1

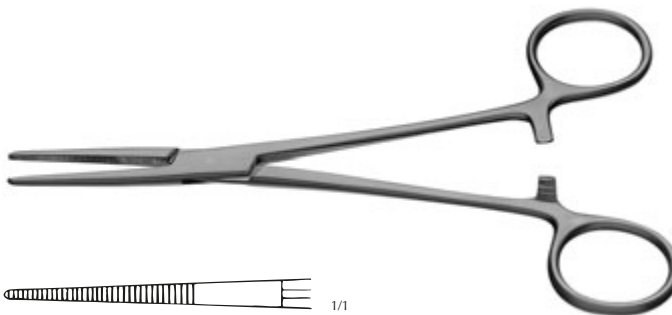

**Rankin-Kelly**

gerade - straight - recta

**AI 170-16** 16 cm / 6¼"

gebogen - curved - curva

**AI 171-16** 16 cm / 6¼"



1/1



**Adson**

gerade - straight - recta

**AI 180-18** 18 cm / 7"

gebogen - curved - curva

**AI 181-18** 18 cm / 7"

1 x 2 Zähne - 1 x 2 teeth - 1 x 2 dientes

gerade - straight - recta

**AI 182-18** 18 cm / 7"

1 x 2 Zähne - 1 x 2 teeth - 1 x 2 dientes

gebogen - curved - curva

**AI 183-18** 18 cm / 7"



1/1

**Arterienklemmen**  
**Hemostatic Forceps**  
**Pinzas hemostáticas**

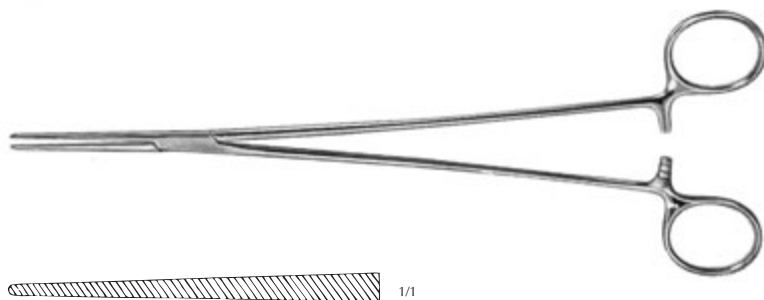

**Bengolea**

gerade - straight - recta

**AI 200-20** 20 cm / 8"

**AI 200-26** 26 cm / 10¼"

gebogen - curved - curva

**AI 201-20** 20 cm / 8"

**AI 201-26** 26 cm / 10¼"

1 x 2 Zähne - 1 x 2 teeth - 1 x 2 dientes

gerade - straight - recta

**AI 206-20** 20 cm / 8"

**AI 206-26** 26 cm / 10¼"

1 x 2 Zähne - 1 x 2 teeth - 1 x 2 dientes

gebogen - curved - curva

**AI 207-20** 20 cm / 8"

**AI 207-26** 26 cm / 10¼"

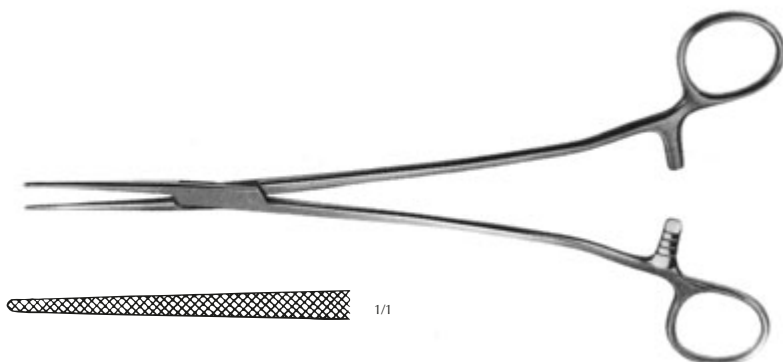

**Bengolea modif.**

gerade - straight - recta

**AI 210-20** 20 cm / 8"

**AI 210-22** 22 cm / 8¾"

**AI 210-26** 26 cm / 10¼"

gebogen - curved - curva

**AI 211-20** 20 cm / 8"

**AI 211-22** 22 cm / 8¾"

**AI 211-26** 26 cm / 10¼"

1 x 2 Zähne - 1 x 2 teeth - 1 x 2 dientes

gerade - straight - recta

**AI 216-20** 20 cm / 8"

**AI 216-22** 22 cm / 8¾"

**AI 216-26** 26 cm / 10¼"

1 x 2 Zähne - 1 x 2 teeth - 1 x 2 dientes

gebogen - curved - curva

**AI 217-20** 20 cm / 8"

**AI 217-22** 22 cm / 8¾"

**AI 217-26** 26 cm / 10¼"

**Arterien- und Ligaturklemmen**  
**Hemostatic and Ligature Forceps**  
**Pinzas hemostáticas y para ligaduras**

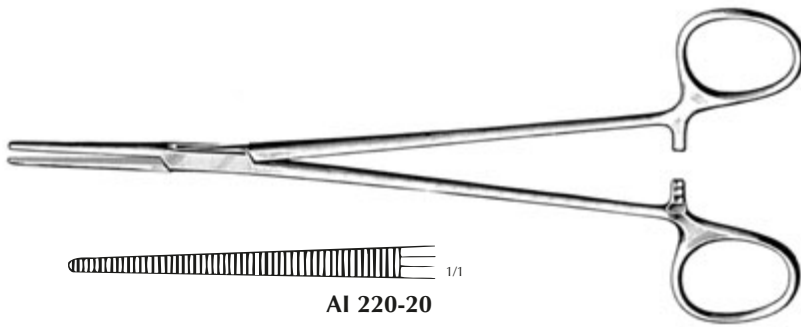

**Heiss**

gerade - straight - recta

**AI 220-20** 20 cm / 8"

leicht gebogen - light curved - curva ligera

**AI 221-20** 20 cm / 8"

stark gebogen - strong curved - curva fuerte

**AI 225-20** 20 cm / 8"

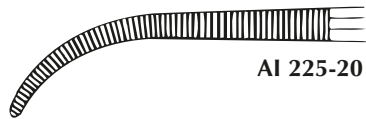

**Sarot**

gerade - straight - recta

**AI 230-24** 24 cm / 9½"

gebogen - curved - curva

**AI 231-24** 24 cm / 9½"



**Crafoord**

gebogen - curved - curva

**AI 241-18** 18 cm / 7"

**AI 241-24** 24 cm / 9½"

**Arterienklemmen**  
**Hemostatic Forceps**  
**Pinzas hemostáticas**

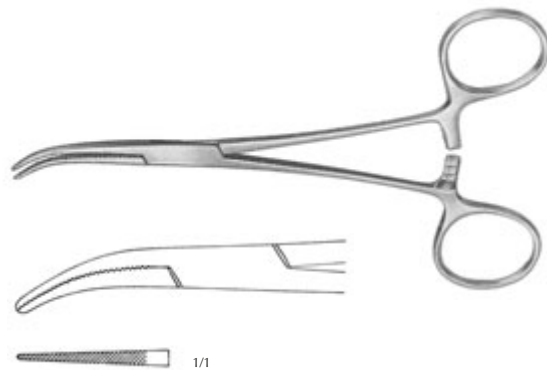

**Dandy**

seitlich gebogen - laterally curved – curva lateral-  
mente

**AI 291-14** 14,5 cm / 5¾"

seitlich gebogen - laterally curved – curva lateral-  
mente

1 x 2 Zähne – 1 x 2 teeth – 1 x 2 dientes

**AI 297-14** 14,5 cm / 5¾"

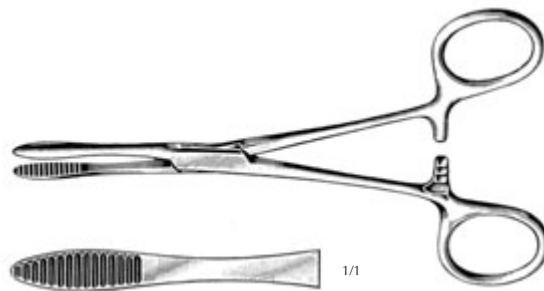

**Pean**

kurzfassend - short jaw - bocas cortas

**AI 320-14** 14 cm / 5½"

**AI 320-16** 16 cm / 6¼"



**Pean**

feines Modell - fine pattern - modelo delgado

gerade - straight - recta

**AI 330-13** 13 cm / 5"

**AI 330-14** 14 cm / 5½"

**AI 330-16** 16 cm / 6¼"

gebogen - curved - curva

**AI 331-13** 13 cm / 5"

**AI 331-14** 14 cm / 5½"

**AI 331-16** 16 cm / 6¼"

**Arterienklemmen**  
**Hemostatic Forceps**  
**Pinzas hemostáticas**

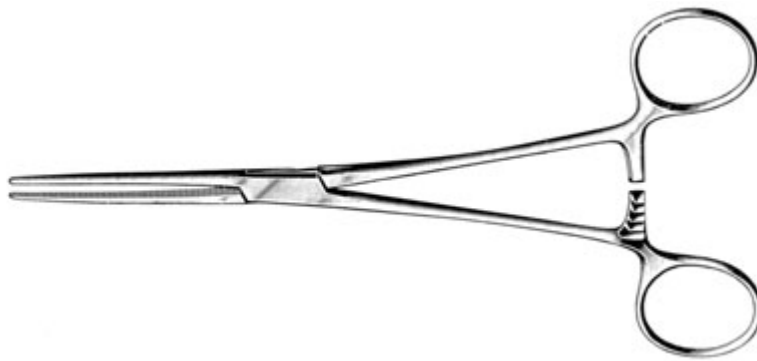

**Pean (Rochester)**

gerade - straight - recta

<b>AI 332-14</b>	14 cm / 5½"
<b>AI 332-16</b>	16 cm / 6¼"
<b>AI 332-18</b>	18 cm / 7"
<b>AI 332-20</b>	20 cm / 8"
<b>AI 332-22</b>	22 cm / 8¾"
<b>AI 332-24</b>	24 cm / 9½"
<b>AI 332-26</b>	26 cm / 10¼"
<b>AI 332-30</b>	30 cm / 12"

gebogen - curved - curva

<b>AI 333-14</b>	14 cm / 5½"
<b>AI 333-16</b>	16 cm / 6¼"
<b>AI 333-18</b>	18 cm / 7"
<b>AI 333-20</b>	20 cm / 8"
<b>AI 333-22</b>	22 cm / 8¾"
<b>AI 333-24</b>	24 cm / 9½"
<b>AI 333-26</b>	26 cm / 10¼"
<b>AI 333-30</b>	30 cm / 12"



**Roberts**

gerade - straight - recta

<b>AI 340-22</b>	22 cm / 8¾"
------------------	-------------

gebogen - curved - curva

<b>AI 341-22</b>	22 cm / 8¾"
------------------	-------------

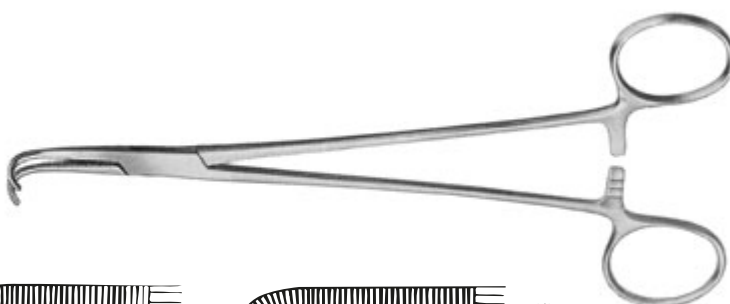

**Negus**

<b>AI 351-01</b>	19 cm / 7½"
------------------	-------------

<b>AI 351-02</b>	19 cm / 7½"
------------------	-------------

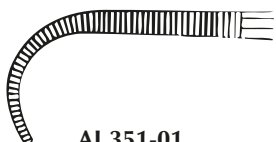

**Arterienklemmen**  
**Hemostatic Forceps**  
**Pinzas hemostáticas**

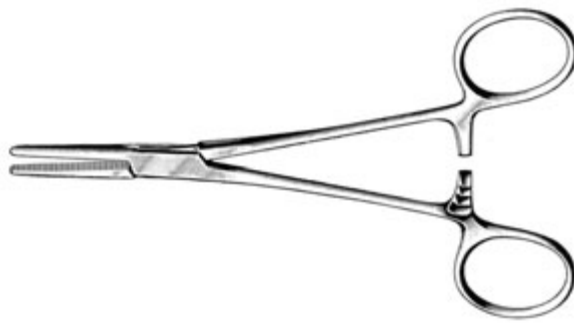

**Spencer-Wells**

gerade - straight - recta

<b>AI 360-13</b>	13 cm / 5"
<b>AI 360-14</b>	14 cm / 5½"
<b>AI 360-15</b>	15 cm / 6"
<b>AI 360-18</b>	18 cm / 7"
<b>AI 360-20</b>	20 cm / 8"

gebogen - curved - curva

<b>AI 361-13</b>	13 cm / 5"
<b>AI 361-14</b>	14 cm / 5½"
<b>AI 361-15</b>	15 cm / 6"
<b>AI 361-18</b>	18 cm / 7"
<b>AI 361-20</b>	20 cm / 8"

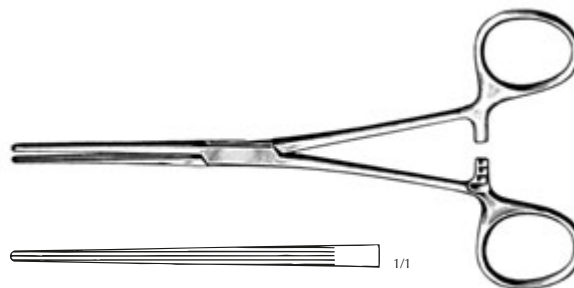

**Bainbridge**

gerade - straight - recta

<b>AI 370-15</b>	15 cm / 6"
<b>AI 370-18</b>	18 cm / 7"

gebogen - curved - curva

<b>AI 371-15</b>	15 cm / 6"
<b>AI 371-18</b>	18 cm / 7"

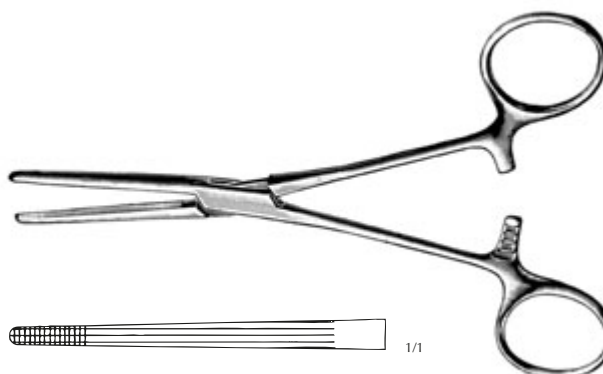

**Rochester-Carmalt**

gerade - straight - recta

<b>AI 380-16</b>	16 cm / 6¼"
<b>AI 380-20</b>	20 cm / 8"

gebogen - curved - curva

<b>AI 381-16</b>	16 cm / 6¼"
<b>AI 381-20</b>	20 cm / 8"

## Arterienklemmen Hemostatic Forceps Pinzas hemostáticas

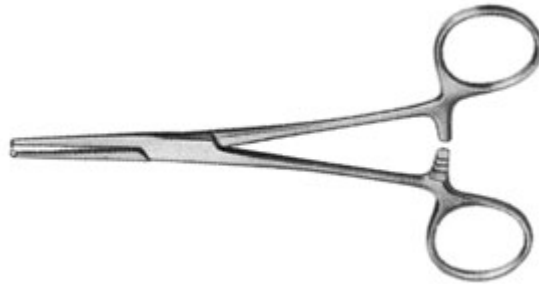

### Baby-Kocher

1 x 2 Zähne - 1 x 2 teeth - 1 x 2 dientes  
gerade - straight - recta

**AI 396-14** 14 cm / 5½"

1 x 2 Zähne - 1 x 2 teeth - 1 x 2 dientes  
gebogen - curved - curva

**AI 397-14** 14 cm / 5½"



### Kocher

*feines Modell - fine pattern - modelo delgado*

1 x 2 Zähne - 1 x 2 teeth - 1 x 2 dientes  
gerade - straight - recta

**AI 406-13** 13 cm / 5"

**AI 406-14** 14 cm / 5½"

**AI 406-16** 16 cm / 6¼"

1 x 2 Zähne - 1 x 2 teeth - 1 x 2 dientes  
gebogen - curved - curva

**AI 407-13** 13 cm / 5"

**AI 407-14** 14 cm / 5½"

**AI 407-16** 16 cm / 6¼"



### Kocher (Rochester-Ochsner)

1 x 2 Zähne - 1 x 2 teeth - 1 x 2 dientes  
gerade - straight - recta

**AI 416-14** 14 cm / 5½"

**AI 416-16** 16 cm / 6¼"

**AI 416-18** 18 cm / 7"

**AI 416-20** 20 cm / 8"

**AI 416-22** 22 cm / 8¾"

**AI 416-24** 24 cm / 9½"

**AI 416-26** 26 cm / 10¼"

**AI 416-30** 30 cm / 12"

1 x 2 Zähne - 1 x 2 teeth - 1 x 2 dientes  
gebogen - curved - curva

**AI 417-14** 14 cm / 5½"

**AI 417-16** 16 cm / 6¼"

**AI 417-18** 18 cm / 7"

**AI 417-20** 20 cm / 8"

**AI 417-22** 22 cm / 8¾"

**AI 417-24** 24 cm / 9½"

**AI 417-26** 26 cm / 10¼"

**AI 417-30** 30 cm / 12"

**Präparier- und Ligaturklemmen**  
**Dissecting and Ligature Clamps**  
**Pinzas de disección y ligaduras**

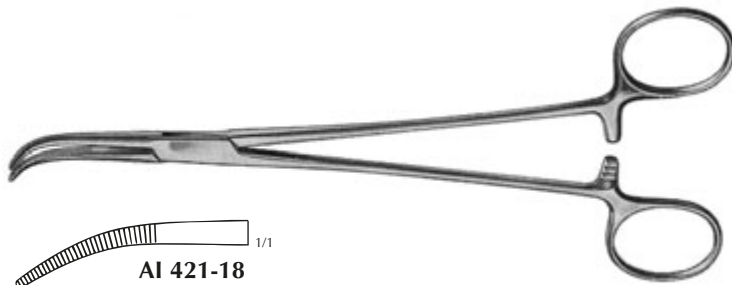

**Schnidt**

leicht gebogen - light curved - curva ligera

**AI 421-18** 18 cm / 7"

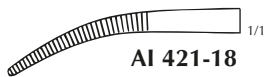

**AI 421-18**

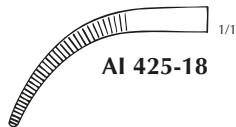

**AI 425-18**

stark gebogen - strong curved - curva fuerte

**AI 425-18** 18 cm / 7"

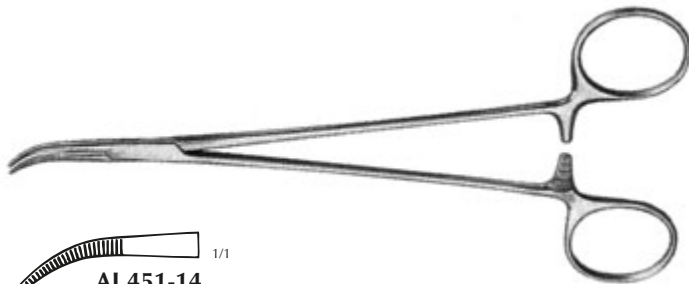

**Baby-Mixer (Baby-Adson)**

leicht gebogen - light curved - curva ligera

**AI 451-14** 14 cm / 5½"

**AI 451-18** 18 cm / 7"



**AI 451-14**

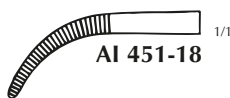

**AI 451-18**

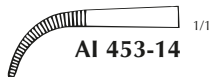

**AI 453-14**

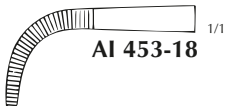

**AI 453-18**

stark gebogen - strong curved - curva fuerte

**AI 453-14** 14 cm / 5½"

**AI 453-18** 18 cm / 7"

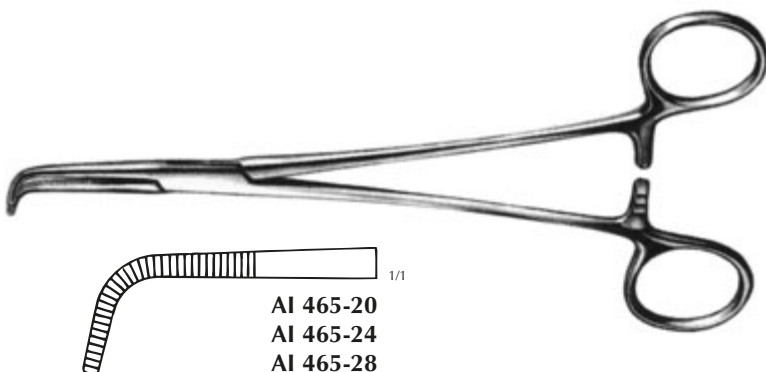

**Kantrowitz**

gebogen - curved - curva

**AI 465-20** 20 cm / 8"

**AI 465-24** 24 cm / 9½"

**AI 465-28** 28 cm / 11"

**AI 465-20**

**AI 465-24**

**AI 465-28**



**Präparier- und Ligaturklemmen**  
**Dissecting and Ligature Clamps**  
**Pinzas de disección y ligaduras**

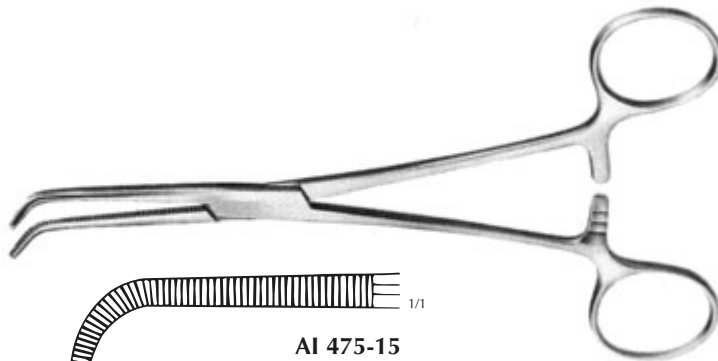

AI 475-15

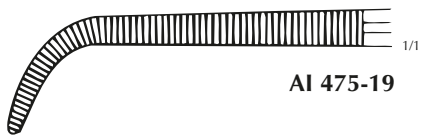

AI 475-19

**Mixer**

gebogen - curved - curva

AI 475-15 15,5 cm / 6¼"

AI 475-19 19 cm / 7½"

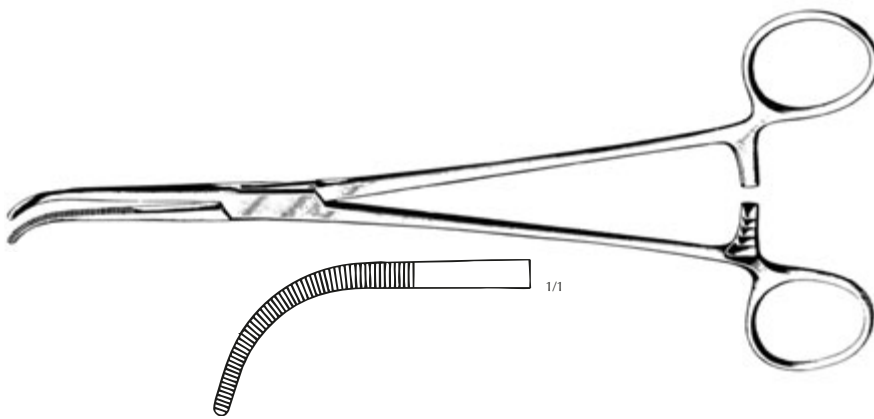

**Mixer**

gebogen - curved - curva

AI 483-22 22 cm / 8¾"

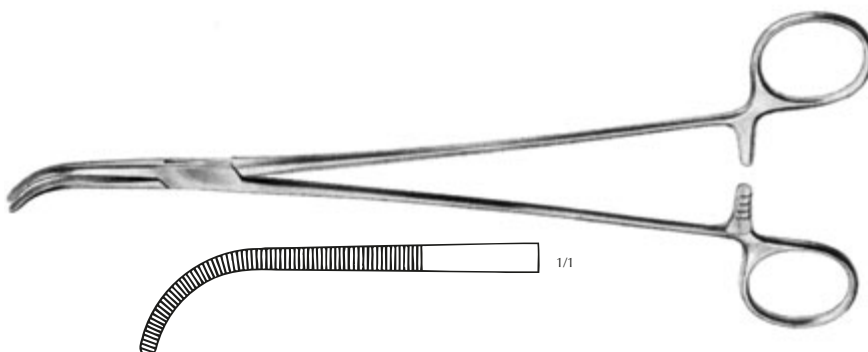

**Mixer**

gebogen - curved - curva

AI 485-23 23 cm / 9"

**Präparier- und Ligaturklemmen**  
**Dissecting and Ligature Clamps**  
**Pinzas de disección y ligaduras**



**Gemini**

gebogen - curved - curva

AI 535-14	14 cm / 5½"
AI 535-16	16 cm / 6¼"
AI 535-18	18 cm / 7"
AI 535-20	20 cm / 8"
AI 535-23	23 cm / 9"
AI 535-25	25 cm / 10"
AI 535-28	28 cm / 11"



**Mixer-Shaugnessy**

AI 541-19	19 cm / 7½"
-----------	-------------



**Wickström**

AI 547-21	21 cm / 8¼"
AI 547-24	24 cm / 9½"

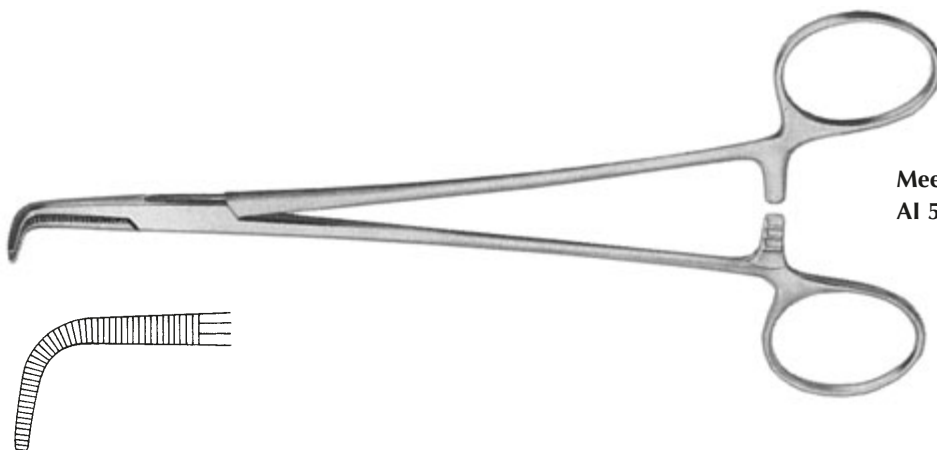

**Meeker**

AI 549-27	27 cm / 10¾"
-----------	--------------

**Präparier- und Ligaturklemmen**  
**Dissecting and Ligature Clamps**  
**Pinzas de disección y ligaduras**

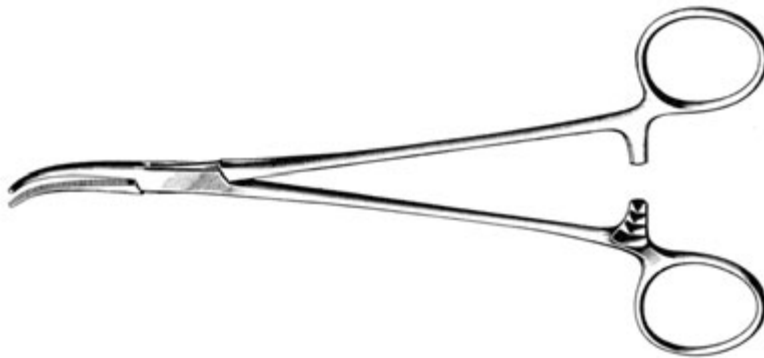

**Overholt-Geissendörfer**  
gebogen - curved - curva

21 cm / 8<sup>1</sup>/<sub>4</sub>"  
AI 551-01  
AI 551-02  
AI 551-03  
AI 551-04  
AI 551-05  
AI 551-06  
AI 551-07

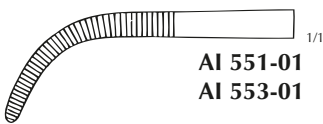

AI 551-01  
AI 553-01

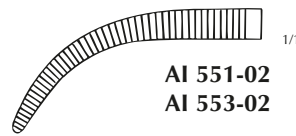

AI 551-02  
AI 553-02

27 cm / 10<sup>3</sup>/<sub>4</sub>"  
AI 553-01  
AI 553-02  
AI 553-03  
AI 553-04  
AI 553-05  
AI 553-06  
AI 553-07

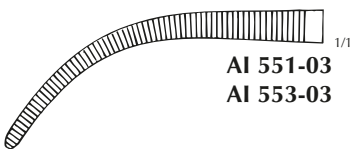

AI 551-03  
AI 553-03

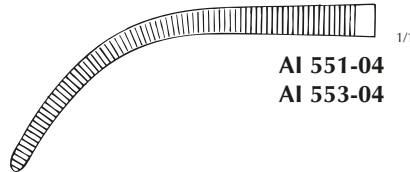

AI 551-04  
AI 553-04

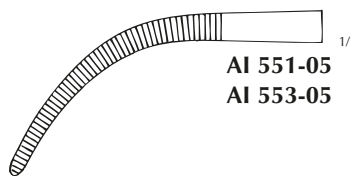

AI 551-05  
AI 553-05

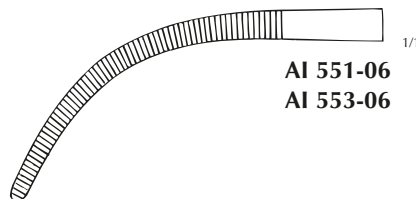

AI 551-06  
AI 553-06

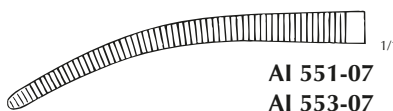

AI 551-07  
AI 553-07

**Präparier- und Ligaturklemmen**  
**Dissecting and Ligature Clamps**  
**Pinzas de disección y ligaduras**



**Rumel**  
 23 cm / 9"  
 AI 561-01 #1  
 AI 561-02 #2  
 AI 561-03 #3  
 AI 561-04 #4  
 AI 561-05 #5

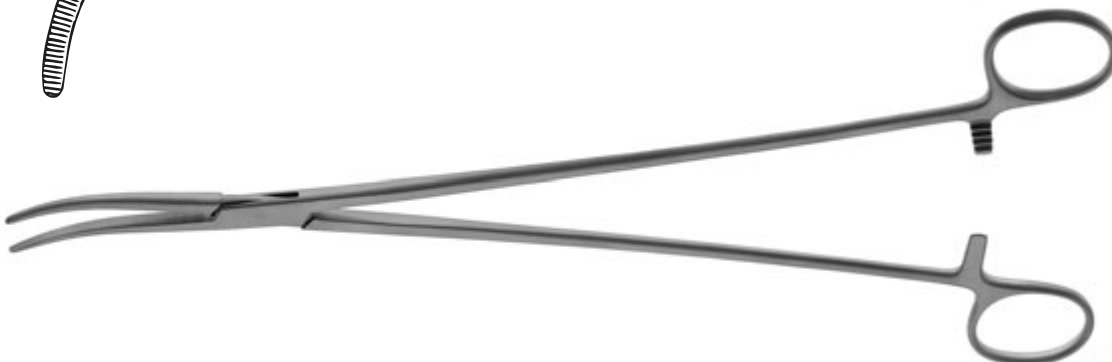
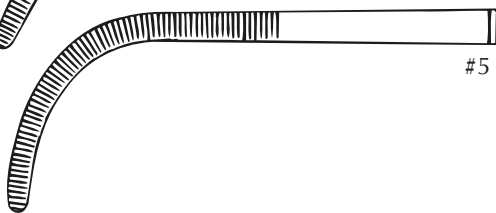
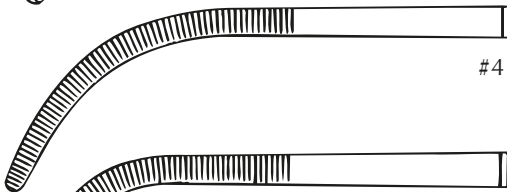
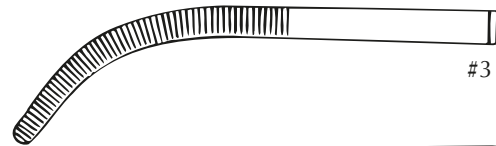
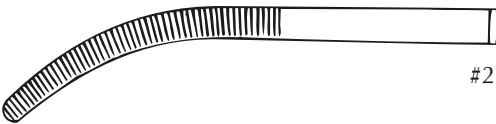
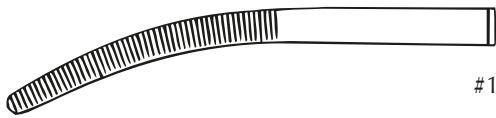

**Zenker**  
 leicht gebogen – light curved – curva ligera  
 AI 571-01 29,5 cm / 11¾"

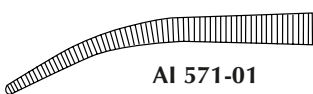

stark gebogen – strong curved – curva fuerte  
 AI 571-02 29,5 cm / 11¾"

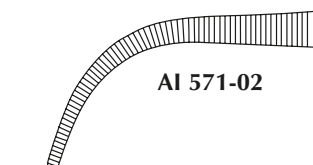

**Gallenkanalklemmen**  
**Gall Duct Clamps**  
**Pinzas para conducto biliar**

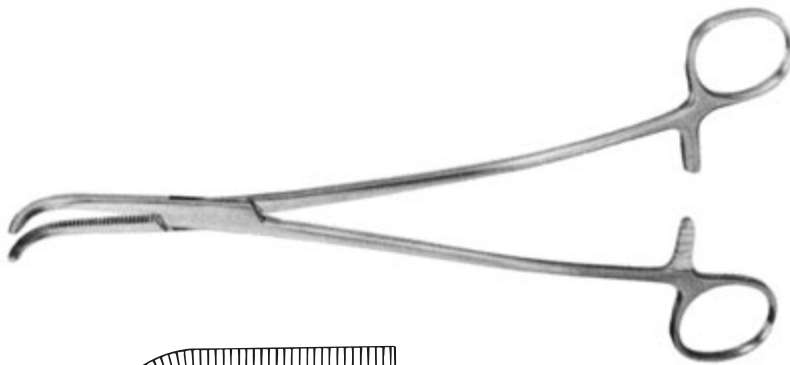

**Gray**  
**AI 583-22** 22 cm / 8<sup>3</sup>/<sub>4</sub>"  
**AI 585-23** 23 cm / 9"

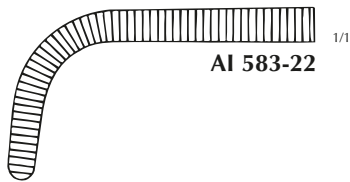

**AI 583-22**

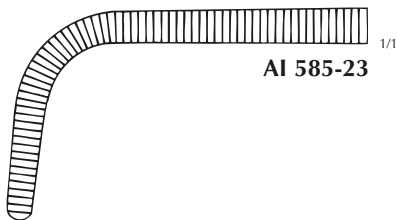

**AI 585-23**



**Desjardins**  
**AI 595-21** 21 cm / 8<sup>1</sup>/<sub>4</sub>"

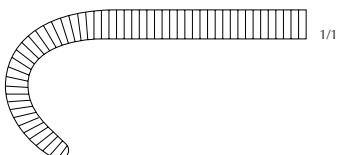

**Gallenkanalklemmen**  
**Gall Duct Clamps**  
**Pinzas para conducto biliar**



**Lahey**  
**AI 611-19** 19 cm / 7½"  
**AI 611-23** 23 cm / 9"

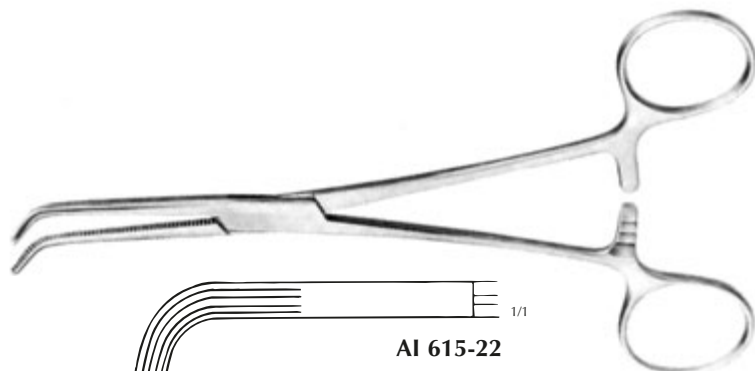
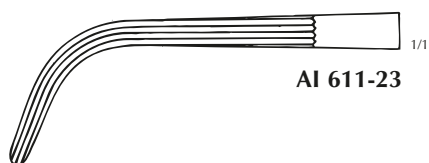
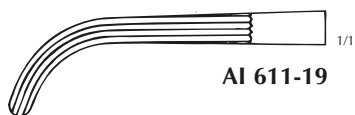

**Mixer**  
**AI 615-22** 22 cm / 8¾"  
**AI 615-25** 25 cm / 10"  
**AI 615-28** 28 cm / 11"

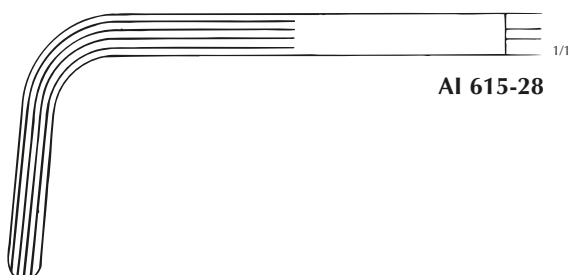
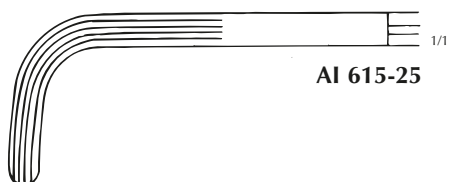
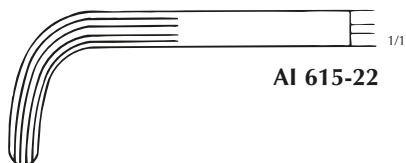

**Nierenstielklemmen, Hysterektomieklemmen**  
**Kidney Pedicle Clamps, Hysterectomy Clamps**  
**Pinzas para pedúnculos renales, pinzas para histerectomía**

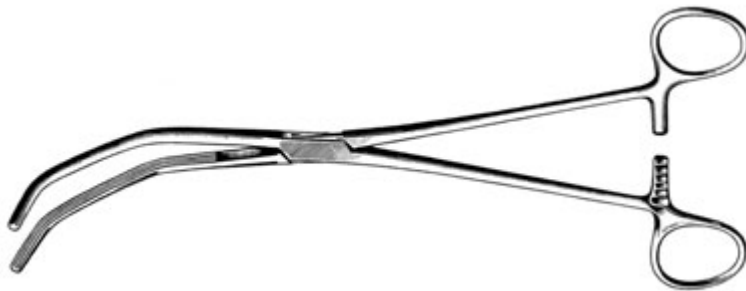

**Herrick**  
AI 621-23 23 cm / 9"



**Guyon**  
AI 651-20 20 cm / 8"  
AI 651-22 22 cm / 8¾"  
AI 651-24 24 cm / 9½"



**Heaney**  
1 x 1 Zähne - 1 x 1 teeth - 1 x 1 dientes  
gebogen - curved - curva  
AI 713-21 21 cm / 8¼"  
AI 713-23 23 cm / 9"  
  
2 x 2 Zähne - 2 x 2 teeth - 2 x 2 dientes  
gebogen - curved - curva  
AI 715-21 21 cm / 8¼"  
AI 715-23 23 cm / 9"

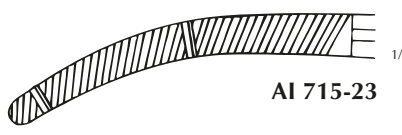
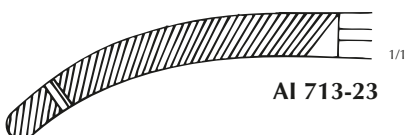

**Hysterektomieklemmen, Peritoneumklemmen**  
**Hysterectomy Clamps, Peritoneal Clamps**  
**Pinzas para histerectomía, Pinzas para peritoneo**

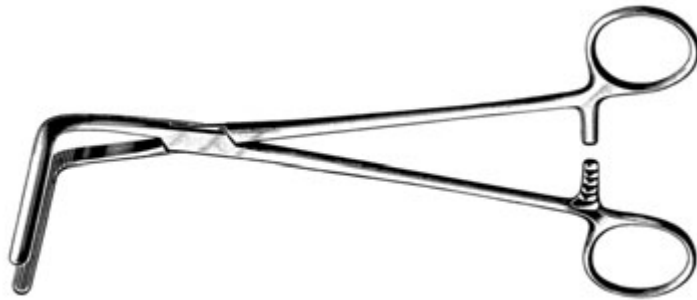

**Wertheim-Cullen**  
AI 725-21 21,5 cm / 8½"

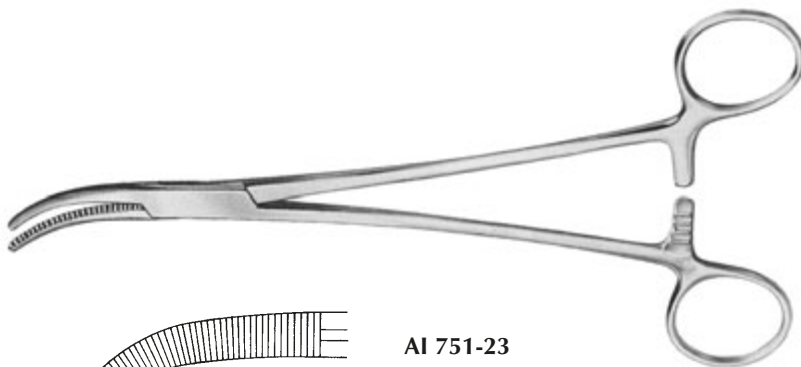

**Moynihan**  
AI 751-23 23 cm / 9"  
AI 751-24 24 cm / 9½"

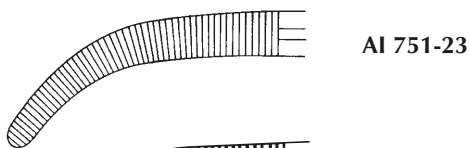

AI 751-23

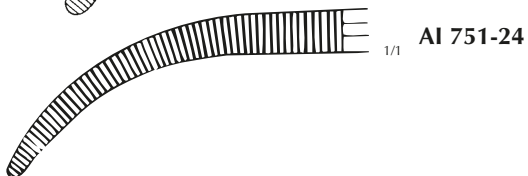

AI 751-24



**Wertheim**  
1 x 2 Zähne - 1 x 2 teeth - 1 x 2 dientes  
stark gebogen - strong curved - curva fuerte  
AI 787-22 22 cm / 8¾"

1 x 2 Zähne - 1 x 2 teeth - 1 x 2 dientes  
leicht gebogen - light curved - curva ligera  
AI 787-23 23 cm / 9"



**Hysterektomieklemmen, Peritoneumklemmen**  
**Hysterectomy Clamps, Peritoneal Clamps**  
**Pinzas para histerectomía, pinzas para peritoneo**

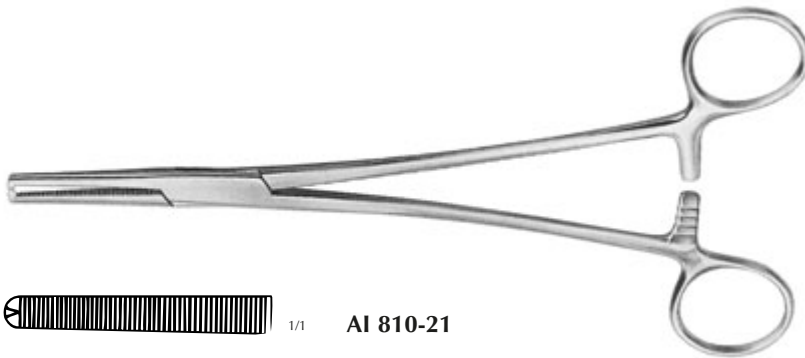

**Phaneuf**

1 x 2 Zähne - 1 x 2 teeth - 1 x 2 dientes  
gerade - straight - recta

**AI 810-21** 21,5 cm / 8½"

gebogen - curved - curva

**AI 811-21** 21,5 cm / 8½"



1/1

**AI 810-21**

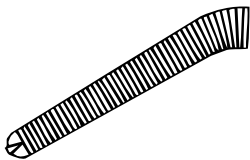

1/1

**AI 811-21**

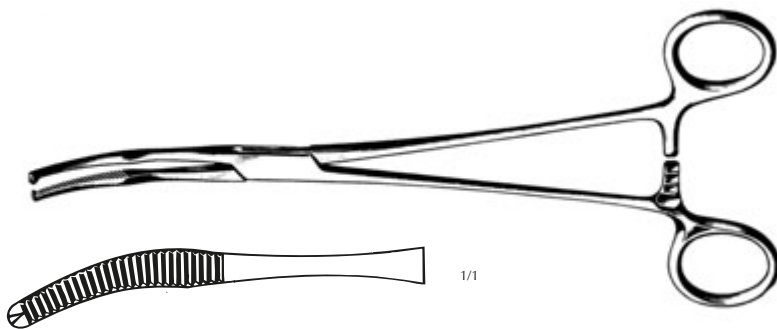

**Mikulicz**

gebogen - curved - curva

**AI 827-20** 20 cm / 8"

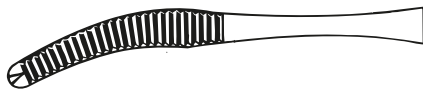

1/1

**Peritoneumklemmen**  
**Peritoneal Clamps**  
**Pinzas para peritoneo**

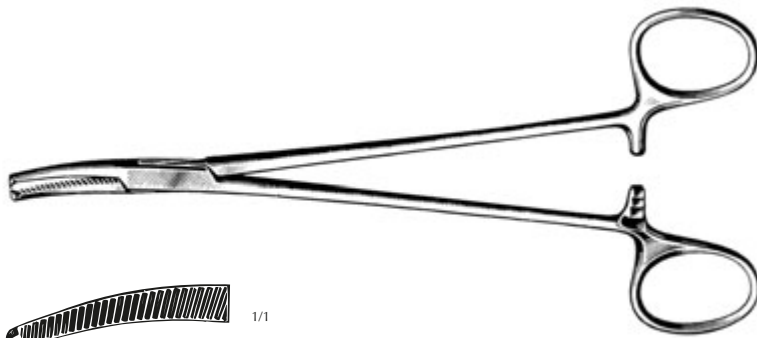

**Faure**

1 x 2 Zähne - 1 x 2 teeth - 1 x 2 dientes  
leicht gebogen - light curved - curva ligera  
**AI 837-20** 20 cm / 8"

1 x 2 Zähne - 1 x 2 teeth - 1 x 2 dientes  
stark gebogen - strong curved - curva fuerte  
**AI 839-20** 20 cm / 8"

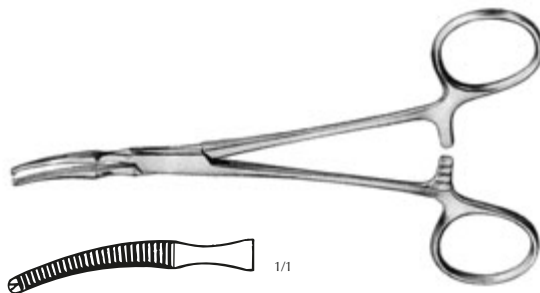

**Baby-Mikulicz**

1 x 2 Zähne - 1 x 2 teeth - 1 x 2 dientes  
gebogen - curved - curva  
**AI 847-14** 14 cm / 5½"

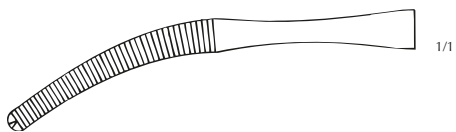
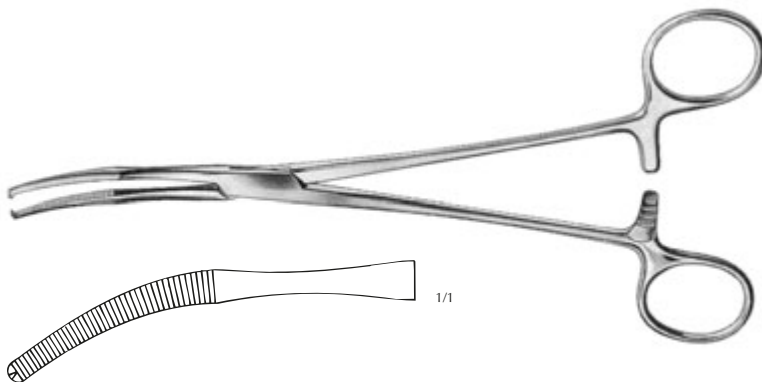

**Mikulicz**

*feines Modell - fine pattern - modelo delgado*  
1 x 2 Zähne - 1 x 2 teeth - 1 x 2 dientes

gebogen - curved - curva  
**AI 857-18** 18 cm / 7"  
**AI 857-20** 20 cm / 8"

**Atraumatische Parametriumklemmen**  
**Atraumatic Parametrium Clamps**  
**Pinzas atraumáticas de parametrio**

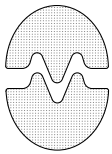

DeBakey-Zahnung  
DeBakey serration  
Bocas tipo DeBakey



**Rogers**

gerade - straight - recta

**AI 900-22** 22 cm / 8¾"

**AI 900-25** 25,5 cm / 10¼"

leicht gebogen - light curved - curva ligera

**AI 901-21** 21,5 cm / 8½"

**AI 901-25** 25 cm / 10"

stark gebogen - strong curved - curva fuerte

**AI 903-21** 21 cm / 8¼"

**AI 903-24** 24,5 cm / 9¾"



**AI 900-22**



**AI 900-25**



**AI 901-21**

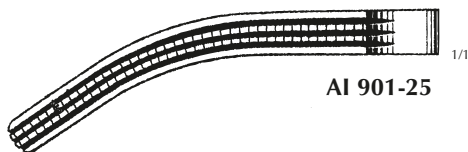

**AI 901-25**

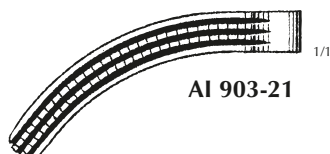

**AI 903-21**

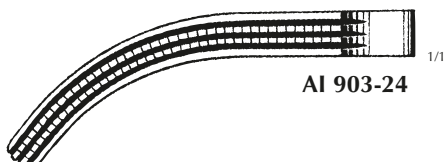

**AI 903-24**

**Tuchklemmen**  
**Towel Forceps**  
**Pinzas de campo**



**Jones**  
gebogen - curved - curva  
AK 101-05 5 cm / 2"  
AK 101-09 9 cm / 3½"



**Schädel**  
gebogen - curved - curva  
AK 111-09 9 cm / 3½"



**Roeder**  
AK 141-13 13 cm / 5"  
AK 141-15 15 cm / 6"

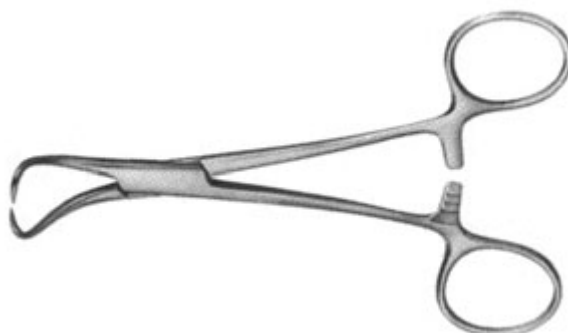

**Backhaus**  
AK 151-08 8 cm / 3¼"  
AK 151-11 11 cm / 4½"  
AK 151-13 13 cm / 5"  
AK 151-15 15 cm / 6"

**Tuchklemmen**  
**Towel Forceps**  
**Pinzas de campo**



**Backhaus**

graziles Modell  
delicate model  
modelo delicado

**AK 155-11** 11 cm / 4½"

**AK 155-13** 13 cm / 5"

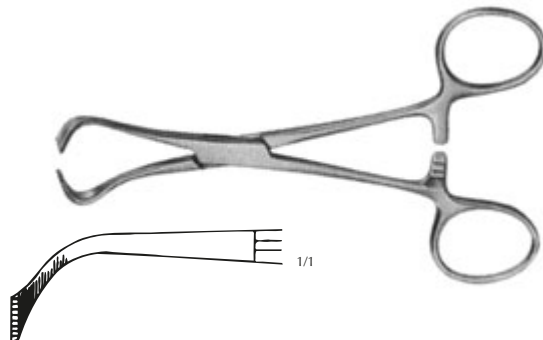

**Lorna**

für Papiertücher  
for paper towels  
para campos de papel

**AK 161-10** 10 cm / 4"

**AK 161-13** 13 cm / 5"



**Bernhard**

**AK 170-16** 16,5 cm / 6½"

**Tuchklemmen**  
**Towel Forceps**  
**Pinzas de campo**



**Lane**  
**AK 180-15** 15 cm / 6"  
**AK 180-18** 18 cm / 7"  
**AK 180-20** 20 cm / 8"

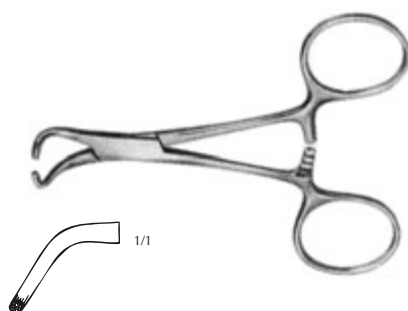

**Tohoku**  
 für Papiertücher  
 for paper towels  
 para campos de papel  
**AK 191-10** 10 cm / 4"  
**AK 191-13** 13 cm / 5"

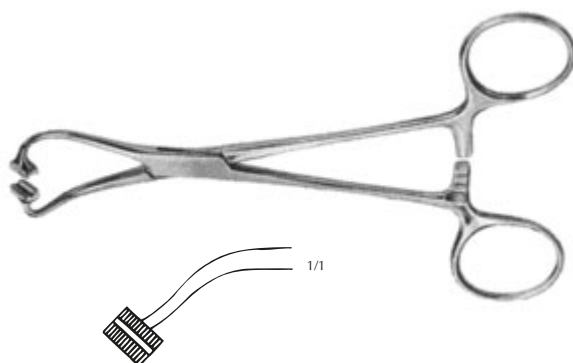

**Peers**  
 für Papiertücher  
 for paper towels  
 para campos de papel  
**AK 211-14** 14,5 cm / 5¾"

**Fadenklemme, Schlauchklemmen**  
**Ligature Forceps, Tubing Clamps**  
**Pinza para hilos, Pinzas cierra-tubos**

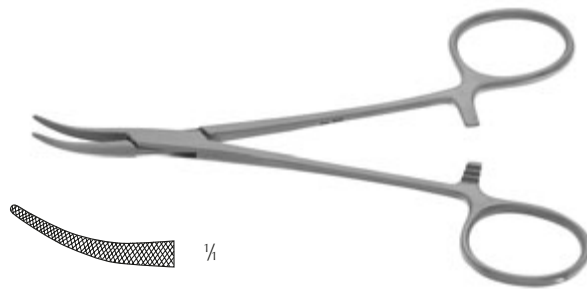

Fadenklemme  
Ligature Forceps  
Pinza para hilos

kreuzgerieftes Maul – cross serrated jaw  
– boca estrada en forma de cruz  
**AK 247-12** 12,5 cm / 5"



**Presbyterian**  
glattes Maul - smooth jaw - bocas lisas  
**AK 260-16** 16,5 cm / 6½"



**Vorse**  
gerieftes Maul - serrated jaw - bocas estriadas  
**AK 280-15** 15 cm / 6"  
**AK 280-18** 18 cm / 7"  
**AK 280-20** 20 cm / 8"



**Vorse**  
mit Schutzbügel, gerieftes Maul  
with guard, serrated jaw  
con protector, bocas estriadas  
**AK 290-15** 15 cm / 6"  
**AK 290-18** 18 cm / 7"  
**AK 290-20** 20 cm / 8"

## Tupferzangen

### Sponge Holding Forceps

### Pinzas para tapones



#### Ulrich

gerade - straight - recta

AL 100-22 22 cm / 8¾"

AL 100-25 25 cm / 10"

AL 100-27 27 cm / 10¾"

gebogen - curved - curva

AL 101-22 22 cm / 8¾"

AL 101-25 25 cm / 10"

AL 101-27 27 cm / 10¾"



#### Lister

gerade - straight - recta

AL 110-13 13 cm / 5"

AL 110-16 16 cm / 6¼"



#### Gross-Maier

gerade - straight - recta

AL 120-20 20 cm / 8"

AL 120-22 22 cm / 8¾"

AL 120-25 25 cm / 10"

AL 120-27 27 cm / 10¾"

gebogen - curved - curva

AL 121-20 20 cm / 8"

AL 121-22 22 cm / 8¾"

AL 121-25 25 cm / 10"

AL 121-27 27 cm / 10¾"



**Tupferzangen**  
**Sponge Holding Forceps**  
**Pinzas para tapones**



**Sims-Maier**

gerade - straight - recta

**AL 130-28** 28 cm / 11"

gebogen - curved - curva

**AL 131-28** 28 cm / 11"

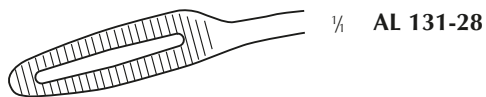

**Collin**

gerade - straight - recta

**AL 150-25** 25 cm / 10"



**Förster**

schmales Maul - narrow jaw - boca estrecha

gerade - straight - recta

**AL 170-25** 25 cm / 10"

gebogen - curved - curva

**AL 171-25** 25 cm / 10"

**Tupferzangen**

**Sponge Holding Forceps**

**Pinzas para tapones**



**Rampley**

gerade - straight - recta

**AL 180-25** 25 cm / 10"



**Förster**

gerieft - serrated - estriada

gerade - straight - recta

**AL 200-18** 18 cm / 7"

**AL 200-20** 20 cm / 8"

**AL 200-25** 25 cm / 10"

gebogen - curved - curva

**AL 201-18** 18 cm / 7"

**AL 201-20** 20 cm / 8"

**AL 201-25** 25 cm / 10"

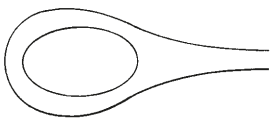

**AL 210-25**

**AL 211-25**

**Förster**

glattes Maul - smooth jaw - boca lisa

gerade - straight - recta

**AL 210-25** 25 cm / 10"

gebogen - curved - curva

**AL 211-25** 25 cm / 10"

**Tupferzangen**  
**Sponge Holding Forceps**  
**Pinzas para tapones**



**Bozemann**

S-förmig - S-shaped - forma-S  
gerieft - serrated - estriada

**AL 221-26** 26 cm / 10½"



**Cheron**

gerade - straight - recta

**AL 310-25** 25 cm / 10"



**Bozemann-Douglas**

S-förmig - S-shaped - forma-S  
gerieft - serrated - estriada

**AL 321-26** 26 cm / 10½"

**Nadelhalter**  
**Needle Holders**  
**Porta-agujas**



**Mathieu**  
AN 100-14 14 cm / 5½"  
AN 100-17 17 cm / 6¾"  
AN 100-20 20 cm / 8"



**Mathieu**  
schmales Maul - narrow jaw - boca estrecha  
AN 120-14 14 cm / 5½"  
AN 120-17 17 cm / 6¾"



**Mathieu**  
Innensperre - interior ratchet - cremallera interior  
AN 150-17 17 cm / 6¾"  
AN 150-20 20 cm / 8"



**Nadelhalter**  
**Needle Holders**  
**Porta-agujas**



**Crile**  
AN 190-15 15 cm / 6"

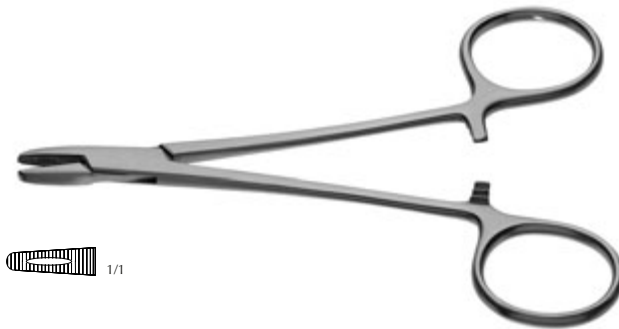

**Derf**  
AN 200-12 12 cm / 4¾"



**Webster**  
glatt – smooth - lisa  
AN 210-13 13 cm / 5"

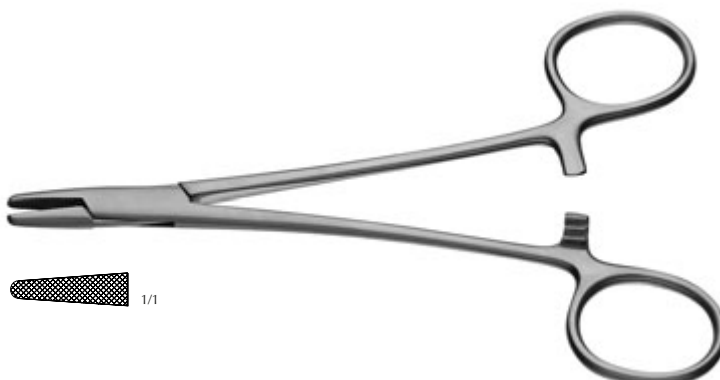

**Hegar-Baumgartner**  
AN 220-14 14 cm / 5½"

**Nadelhalter**  
**Needle Holders**  
**Porta-agujas**

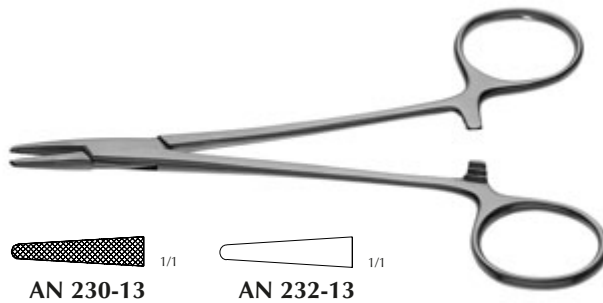

**Halsey**  
gerieft - serrated - estriada  
AN 230-13 13 cm / 5"

glatt - smooth - lisa  
AN 232-13 13 cm / 5"



**Crile-Murray**  
schmales Maul - narrow jaw - boca estrecha  
AN 240-15 15 cm / 6"

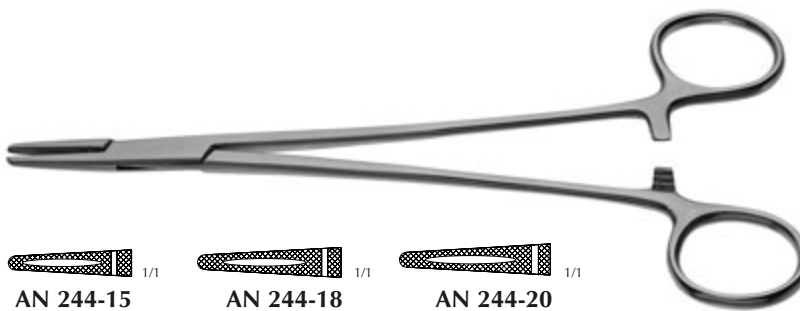

**Crile-Wood**  
AN 244-15 15 cm / 6"  
AN 244-18 18 cm / 7"  
AN 244-20 20 cm / 8"

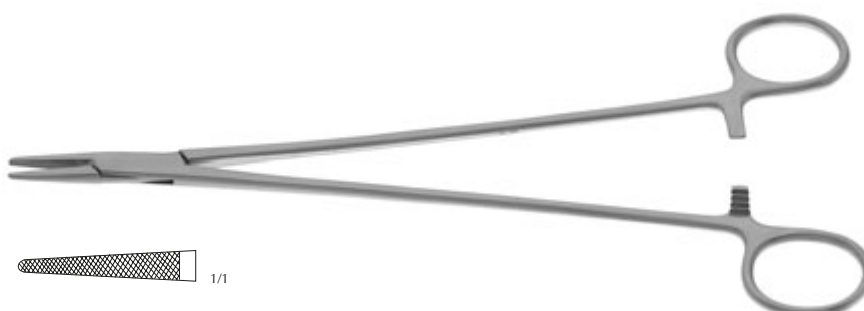

**Jameson**  
AN 280-23 23,5 cm / 9¼"

**Nadelhalter**  
**Needle Holders**  
**Porta-agujas**

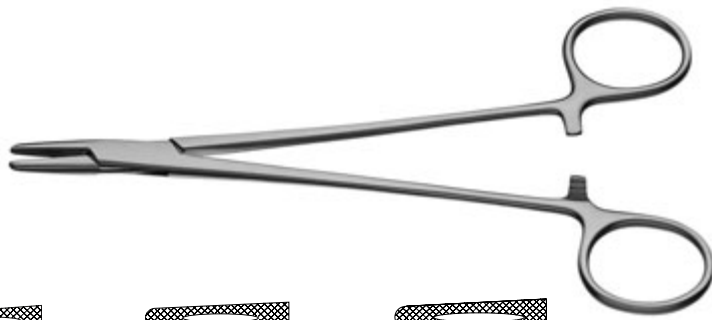

**Mayo-Hegar**

<b>AN 300-14</b>	14 cm / 5½"
<b>AN 300-16</b>	16 cm / 6¼"
<b>AN 300-18</b>	18 cm / 7"
<b>AN 300-20</b>	20 cm / 8"
<b>AN 300-24</b>	24 cm / 9½"
<b>AN 300-26</b>	26 cm / 10¼"
<b>AN 300-30</b>	30 cm / 12"



**AN 300-14**



**AN 300-16**



**AN 300-18**



**AN 300-20**



**AN 300-24**



**AN 300-26**



**AN 300-30**

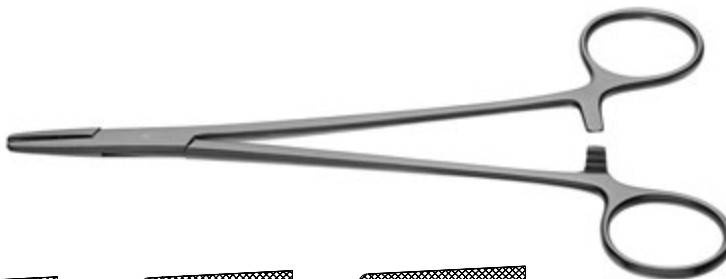

**Mayo-Hegar**

*feines Modell - fine pattern - modelo delgado*

<b>AN 310-16</b>	16 cm / 6¼"
<b>AN 310-18</b>	18 cm / 7"
<b>AN 310-20</b>	20 cm / 8"



**AN 310-16**



**AN 310-18**



**AN 310-20**

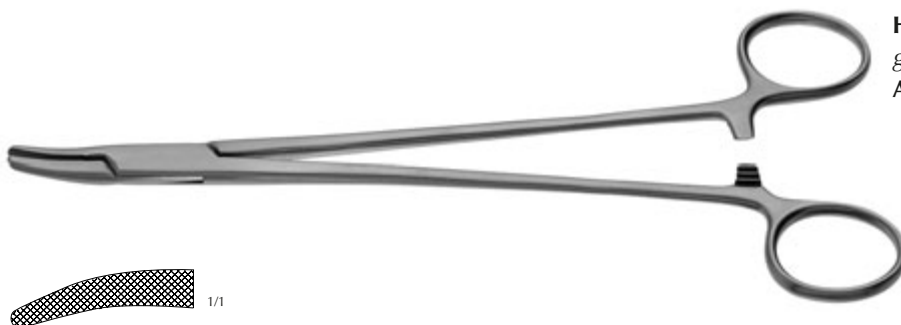

**Heaney**

*gebogen - curved - curva*

<b>AN 321-21</b>	21 cm / 8¼"
------------------	-------------



**Nadelhalter**  
**Needle Holders**  
**Porta-agujas**

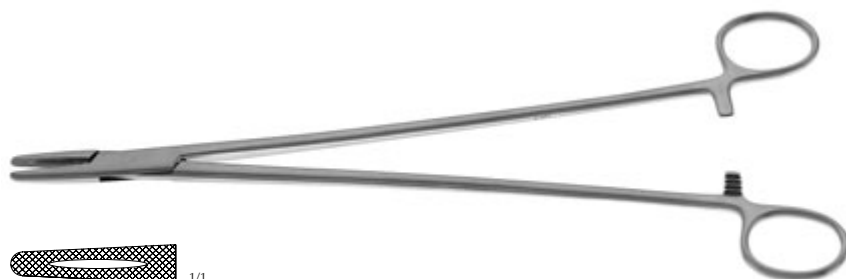

**Masson**  
AN 330-27 27 cm / 10¾"

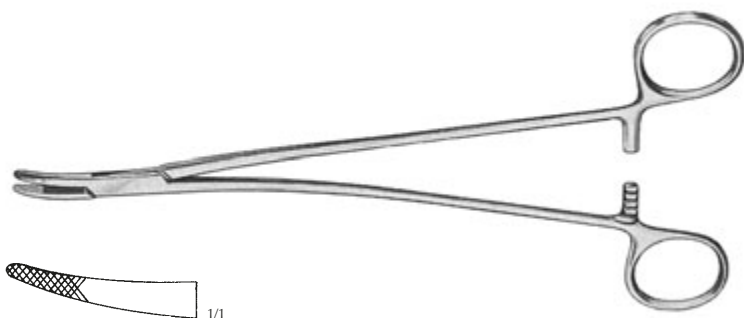

**Stratte**  
AN 350-20 20 cm / 8"  
AN 350-23 23 cm / 9"



**Finochietto**  
gebogen - curved - curva  
AN 351-27 27 cm / 10½"

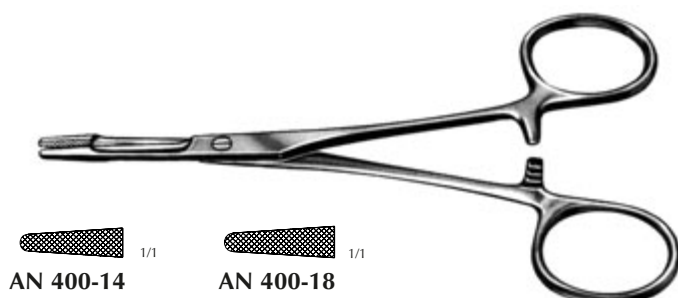

**Olsen-Hegar**  
AN 400-14 14 cm / 5½"  
AN 400-18 18 cm / 7"



**Nadelhalter**  
**Needle Holders**  
**Porta-agujas**



**Gillies**  
AN 431-16 16 cm / 6¼"

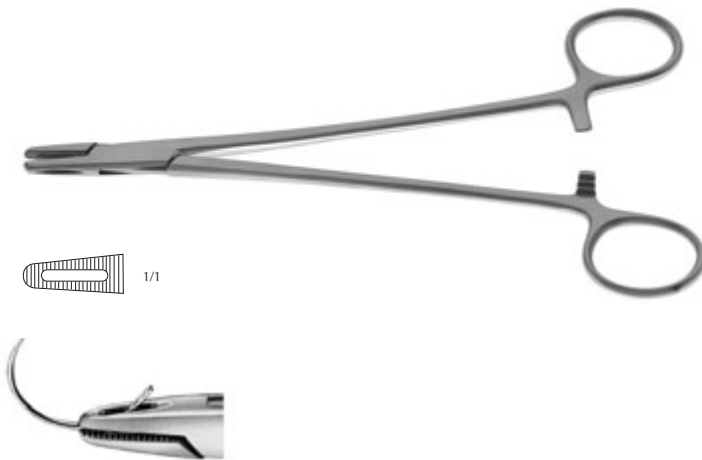

**Adson**  
für Frontnaht – for frontal suture –  
para sutura frontal  
AN 440-17 17 cm / 6¾"

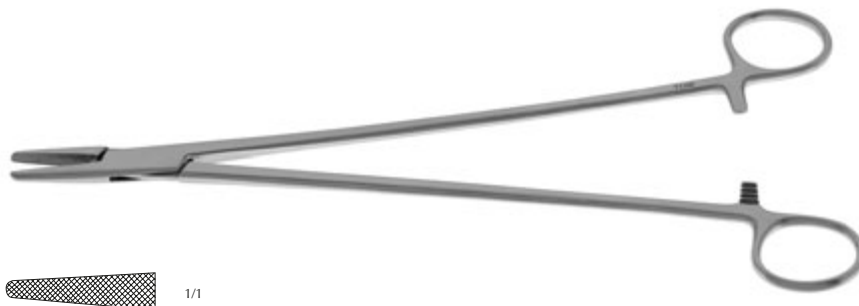

**Wangenstein**  
AN 450-27 27 cm / 10¾"

**Unterbindungsnadeln**  
**Ligature Needles**  
**Agujas para ligaduras**



**Deschamps**  
rechts gebogen, für die linke Hand  
curved to right, for the left hand  
curva a derecha, para la mano izquierda



stumpf - blunt - roma  
**AN 500-20** 20 cm / 8"



**Deschamps**  
links gebogen, für die rechte Hand  
curved to left, for the right hand  
curva a izquierda, para la mano derecha

stumpf - blunt - roma  
**AN 501-20** 20 cm / 8"



**Deschamps**  
rechts gebogen, für die linke Hand  
curved to right, for the left hand  
curva a derecha, para la mano izquierda

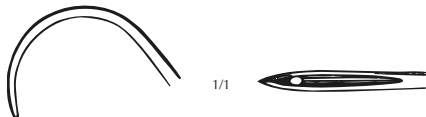

spitz - sharp - aguda  
**AN 504-20** 20 cm / 8"



**Deschamps**  
links gebogen, für die rechte Hand  
curved to left, for the right hand  
curva a izquierda, para la mano derecha

spitz - sharp - aguda  
**AN 505-20** 20 cm / 8"

## Unterbindungsnadeln Ligature Needles Agujas para ligaduras



### Deschamps

rechts gebogen, für die linke Hand  
curved to right, for the left hand  
curva a derecha, para la mano izquierda

stumpf - blunt - roma

AN 510-21 21 cm / 8¼"

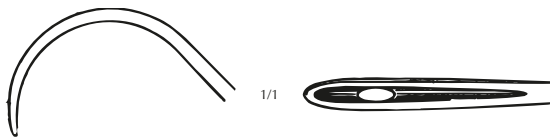

### Deschamps

links gebogen, für die rechte Hand  
curved to left, for the right hand  
curva a izquierda, para la mano derecha

stumpf - blunt - roma

AN 511-21 21 cm / 8¼"



### Deschamps

rechts gebogen, für die linke Hand  
curved to right, for the left hand  
curva a derecha, para la mano izquierda

spitz - sharp - aguda

AN 514-21 21 cm / 8¼"

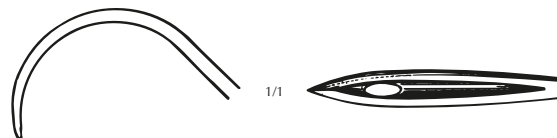

### Deschamps

links gebogen, für die rechte Hand  
curved to left, for the right hand  
curva a izquierda, para la mano derecha

spitz - sharp - aguda

AN 515-21 21 cm / 8¼"

**Unterbindungsnadeln**  
**Ligature Needles**  
**Agujas para ligaduras**

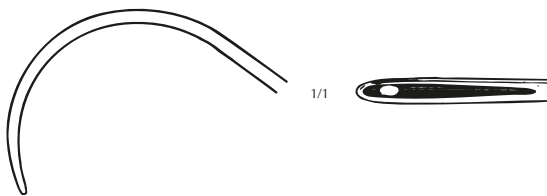

**Deschamps**

rechts gebogen, für die linke Hand  
curved to right, for the left hand  
curva a derecha, para la mano izquierda

stumpf - blunt - roma  
**AN 530-24** 24 cm / 9½"



**Deschamps**

links gebogen, für die rechte Hand  
curved to left, for the right hand  
curva a izquierda, para la mano derecha

stumpf - blunt - roma  
**AN 531-24** 24 cm / 9½"



**Deschamps**

rechts gebogen, für die linke Hand  
curved to right, for the left hand  
curva a derecha, para la mano izquierda

stumpf - blunt - roma  
**AN 600-20** 20 cm / 8"



**Deschamps**

links gebogen, für die rechte Hand  
curved to left, for the right hand  
curva a izquierda, para la mano derecha

stumpf - blunt - roma  
**AN 601-20** 20 cm / 8"

## Unterbindungsnadeln, Führungshohlsonden Ligature Needles and Conductors Agujas para ligaduras, sondas conductoras



**Deschamps**

rechts gebogen, für die linke Hand  
curved to right, for the left hand  
curva a derecha, para la mano izquierda

spitz - sharp - aguda

AN 604-20 20 cm / 8"



**Deschamps**

links gebogen, für die rechte Hand  
curved to left, for the right hand  
curva a izquierda, para la mano derecha

spitz - sharp - aguda

AN 605-20 20 cm / 8"



**Payr**

gerade - straight - recta  
22 cm / 8<sup>3</sup>/<sub>4</sub>"

AN 640-01 5 mm

AN 640-02 8 mm



gebogen - curved - curva

22 cm / 8<sup>3</sup>/<sub>4</sub>"

AN 641-01 5 mm

AN 641-02 8 mm

**Führungshohlsonden**  
**Ligature Conductors**  
**Sondas conductoras**



**König**

Breite - width - anchura 2,8 mm

gebogen - curved - curva

AN 651-01 19,5 cm / 7<sup>3</sup>/<sub>4</sub>"



**König**

Breite - width - anchura 5 mm

gebogen - curved - curva

AN 651-02 19,5 cm / 7<sup>3</sup>/<sub>4</sub>"



**König**

Breite - width - anchura 7 mm

gebogen - curved - curva

AN 651-03 19,5 cm / 7<sup>3</sup>/<sub>4</sub>"



**Schmieden**

Breite - width - anchura 8 mm

gebogen - curved - curva

AN 691-18 18 cm / 7"



**Schmieden-Payr**

Breite - width - anchura 8 mm

gebogen - curved - curva

AN 693-18 18 cm / 7"

**Nahtinstrumente**  
**Suture Instruments**  
**Instrumental para suturas**



**Hegenbarth**  
**AN 810-12** 12,5 cm / 5"



**Wachenfeldt**  
**AN 820-12** 12,5 cm / 5"



**Michel**  
**AN 830-12** 12 cm / 4¾"



**Collin**  
**AN 840-13** 13 cm / 5"



**Michel**  
Packung à 100 Stück  
Verkaufseinheit: 10 Packungen = 1000 Stück

Package of 100 pieces  
Unit for Sale: 10 packages = 1000 each

Paquete de 100 piezas  
Unidad de venta: 10 paquetes = 1000 piezas

- AN 900-07** 7,5 mm
- AN 900-11** 11 mm
- AN 900-12** 12 mm
- AN 900-14** 14 mm
- AN 900-16** 16 mm
- AN 900-18** 18 mm
- AN 900-20** 20 mm
- AN 900-22** 22 mm

## GEOMED® GOLD-GRIP® Hartmetallnadelhalter

GEOMED® hat die GOLD-GRIP® Hartmetall-Nadelhalter ihrem Einsatzgebiet entsprechend mit unterschiedlichen Hartmetalleinlagen bestückt. Einlagen T02 bis 05 sind **geschliffen**, um sicheren und zuverlässigen Halt der Nadel im Einsatz zu bieten.

## GEOMED® GOLD-GRIP® Tungsten-Carbide Needle Holders

GEOMED® has equipped the GOLD-GRIP® needle holders with different tungsten-carbide inserts according to their surgical indication. Inserts P02 - 05 are **ground** for vise-like and reliable stability of the needle while in use.

## GEOMED® GOLD-GRIP® Porta-agujas de carburo de tungsteno

GEOMED® ha equipado los GOLD-GRIP® porta-agujas con placas de carburo de tungsteno adaptadas a las exigencias quirúrgicas. Las placas P02 - 05 son afiladas para conseguir una sujeción adecuada y seguro de la aguja durante su uso.

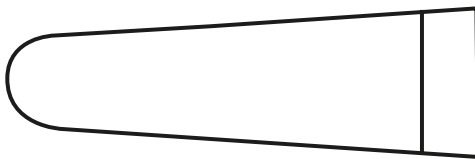

### Glatt – smooth – lisa

empfohlen für Nahtmaterial 9/0 – 11/0  
recommended for suture material 9/0 – 11/0  
recomendado para suturas 9/0 – 11/0

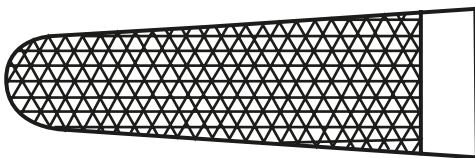

T02

### Mikro – micro – micro

T02 = Teilung 02 = 0,2 mm Abstand zwischen Pyramidenspitzen  
P02 = Pitch 02 = 0,2 mm distance between pyramidal teeth  
P02 = partición 02 = 0,2 mm distancia entre dientes piramidales

empfohlen für Nahtmaterial 6/0 – 10/0  
recommended for suture material 6/0 – 10/0  
recomendado para suturas 6/0 – 10/0

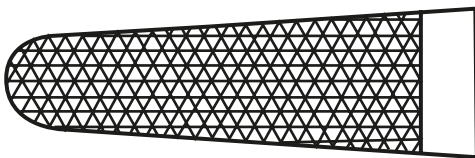

T04

### Fein – fine – delicado

T04 = Teilung 04 = 0,4 mm Abstand zwischen Pyramidenspitzen  
P04 = Pitch 04 = 0,4 mm distance between pyramidal teeth  
P04 = partición 04 = 0,4 mm distancia entre dientes piramidales

empfohlen für Nahtmaterial 4/0 – 6/0  
recommended for suture material 4/0 – 6/0  
recomendado para suturas 4/0 – 6/0

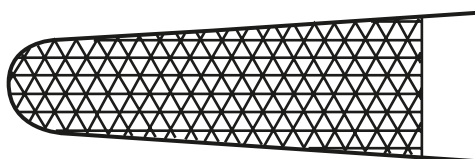

T05

### Normal – regular – regular

T05 = Teilung 05 = 0,5 mm Abstand zwischen Pyramidenspitzen  
P05 = Pitch 05 = 0,5 mm distance between pyramidal teeth  
P05 = partición 05 = 0,5 mm distancia entre dientes piramidales

empfohlen für Nahtmaterial bis 3/0  
recommended for suture material up to 3/0  
recomendado para suturas hasta 4/0 – 6/0



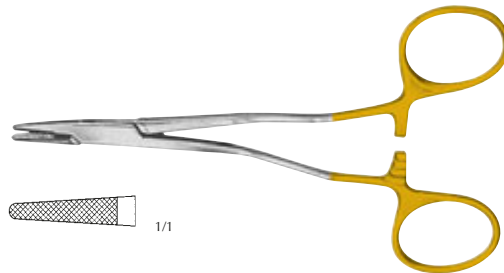

**Kilner**

gerieft T04 – serrated P04 – estriada P04  
AR 091-13 13,5 cm / 5¼"



**Neivert**

ein Ring abgewinkelt – one ring angled –  
un dorado angulado  
gerieft T04 – serrated P04 – estriada P04  
AR 110-13 13 cm / 5"

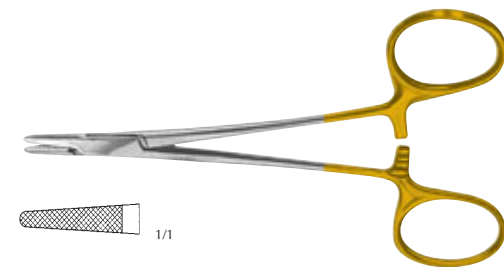

**Converse**

gerieft T04 – serrated P04 – estriada P04  
AR 116-12 12,5 cm / 5"

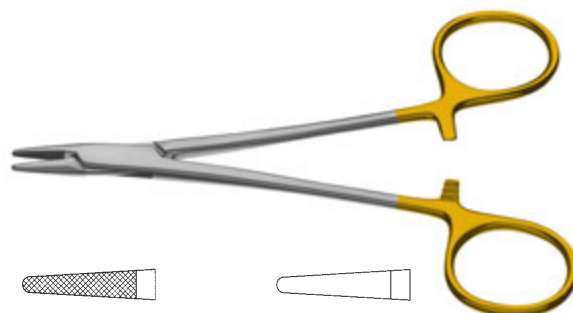

**Halsey**

gerieft T04 - serrated P04 - estriada P04  
AR 120-13 13 cm / 5"

glatt - smooth - lisa  
AR 124-13 13 cm / 5"

AR 120-13

AR 124-13

**Nadelhalter**  
**Needle Holders**  
**Porta-agujas**

**GEOMED GOLD-GRIP**<sup>®</sup>

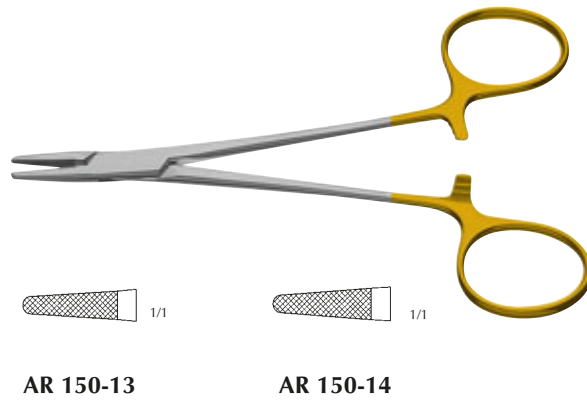

**Hegar-Baumgartner**

gerieft T04 - serrated P04 - estriada P04

AR 150-13      13 cm / 5"

AR 150-14      14 cm / 5½"

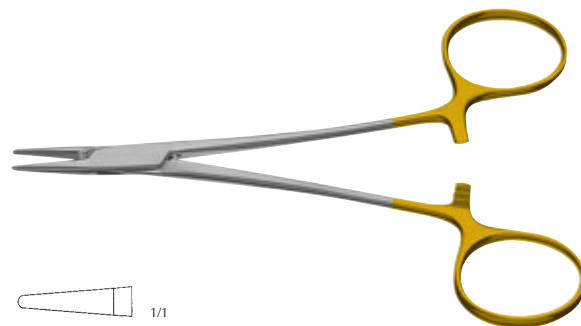

**Webster**

glatt - smooth - lisa

AR 170-13      13 cm / 5"

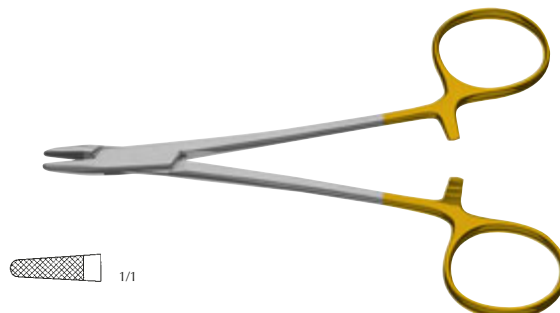

**Derf**

gerieft T04 - serrated P04 - estriada P04

AR 190-12      12 cm / 4¾"

GEOMED GOLD-GRIP<sup>®</sup>

**Nadelhalter**  
**Needle Holders**  
**Porta-agujas**

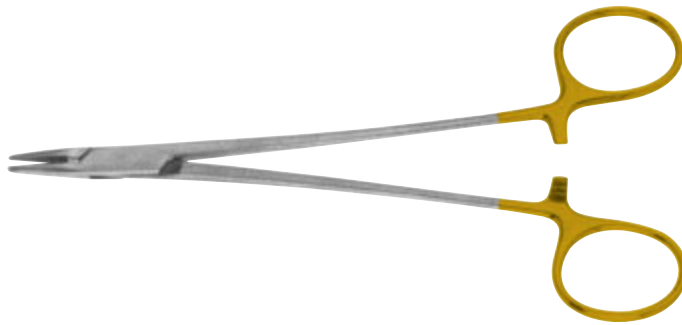

**Mayo-Hegar**

gerieft T05 - serrated P05 - estriada P05

<b>AR 200-16</b>	16 cm / 6¼"
<b>AR 200-18</b>	18 cm / 7"
<b>AR 200-20</b>	20 cm / 8"
<b>AR 200-24</b>	24 cm / 9½"
<b>AR 200-26</b>	26 cm / 10¼"
<b>AR 200-30</b>	30 cm / 12"



**AR 200-16**



**AR 200-18**



**AR 200-20**



**AR 200-24**



**AR 200-26**



**AR 200-30**

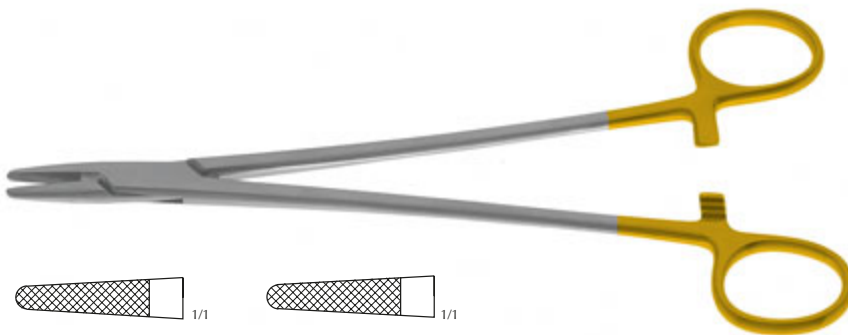

**Mayo-Hegar**

kräftiges Modell – heavy pattern – modelo fuerte

gerieft T05 - serrated P05 - estriada P05

<b>AR 205-20</b>	20 cm / 8"
<b>AR 205-24</b>	24 cm / 9½"

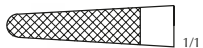

**AR 205-20**



**AR 205-24**

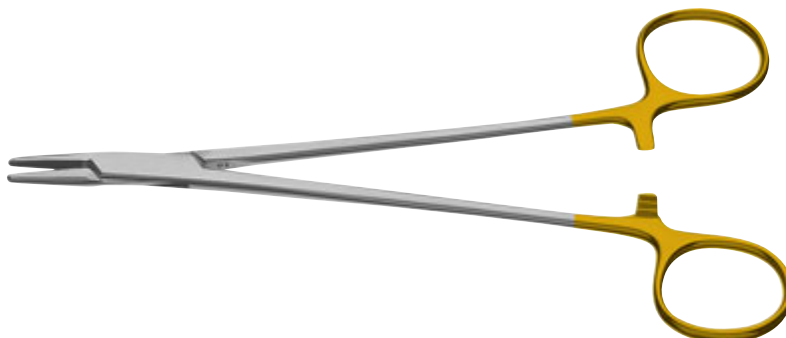

**Crile-Wood**

gerieft T04 - serrated P04 - estriada P04

<b>AR 220-15</b>	15 cm / 6"
<b>AR 220-18</b>	18 cm / 7"
<b>AR 220-20</b>	20 cm / 8"
<b>AR 220-23</b>	23 cm / 9"
<b>AR 220-26</b>	26 cm / 10¼"
<b>AR 220-30</b>	30 cm / 12"



**AR 220-15**



**AR 220-18**



**AR 220-20**



**AR 220-23**



**AR 220-26**



**AR 220-30**

**Nadelhalter**  
**Needle Holders**  
**Porta-agujas**

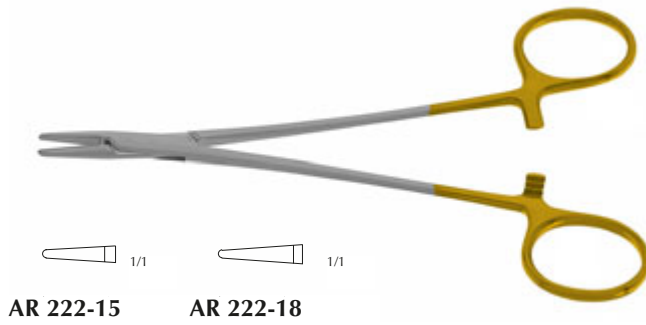

**Crile-Wood**

glatt – smooth – lisa

**AR 222-15** 15 cm / 6"

**AR 222-18** 18 cm / 7"

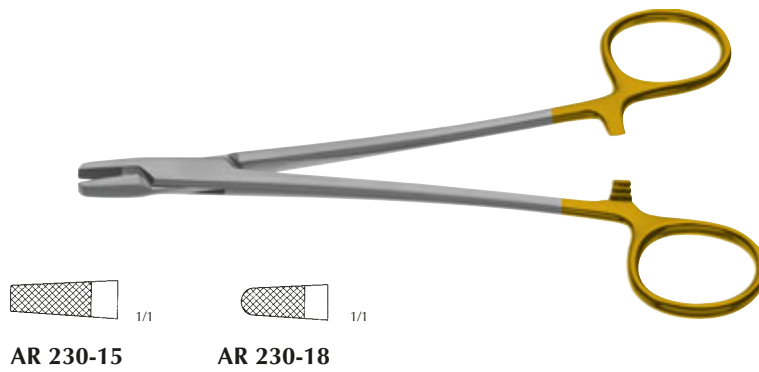

gerieft T05 - serrated P05 - estriada P05

**AR 230-15** 15 cm / 6"

**AR 230-18** 18 cm / 7"

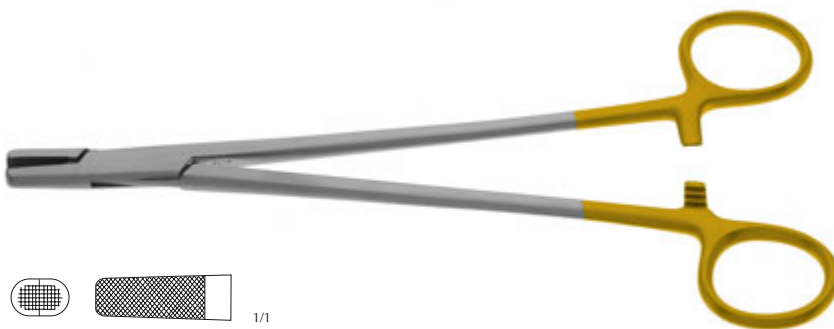

**Baumgartner**

Drahtspannzange – wire twister –

pinza para torcer alambre

**AR 232-20** 20 cm / 8"

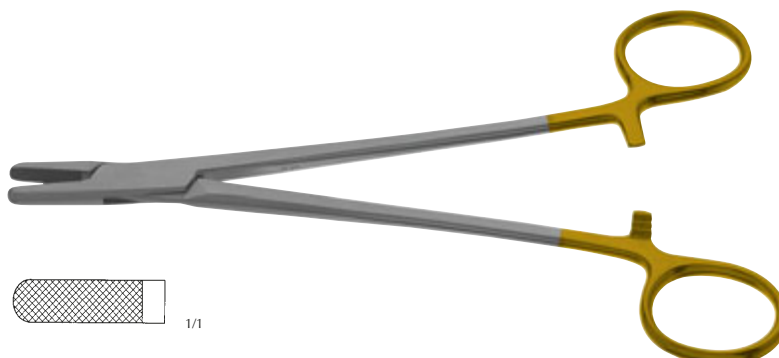

Sternumnadelhalter

Sternum Needle Holder

Porta-aguja para esternón

gerieft T05 - serrated P05 - estriada P05

**AR 240-18** 18,5 cm / 7¼"

GEOMED GOLD-GRIP<sup>®</sup>

Nadelhalter  
Needle Holders  
Porta-agujas

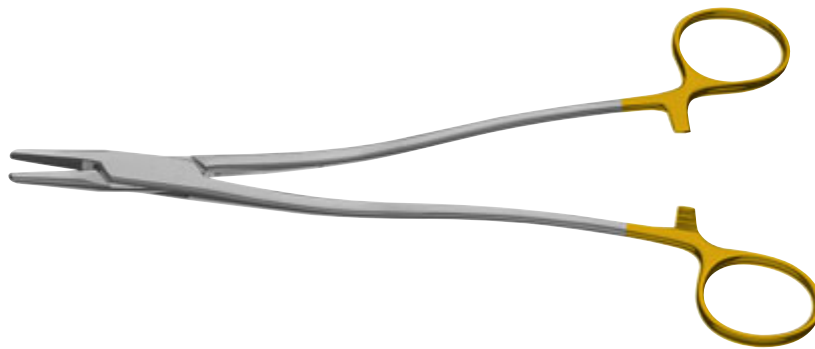

**Bozeman**

gerieft T05 - serrated P05 - estriada P05

AR 250-20 20 cm / 8"

AR 250-24 24 cm / 9½"

AR 250-26 26 cm / 10¼"

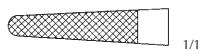

AR 250-20

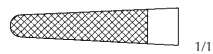

AR 250-24



AR 250-26

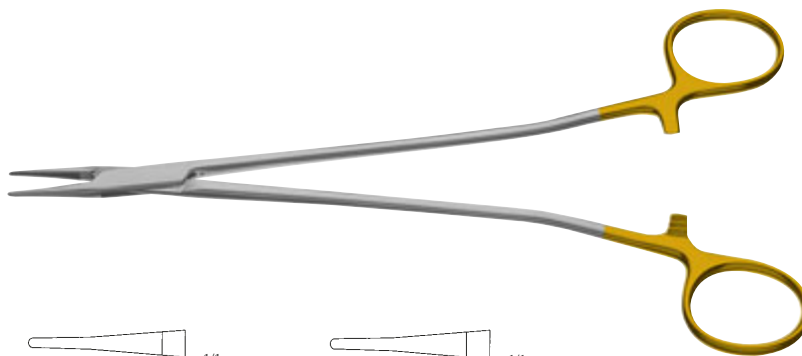

**Mini Sarot**

glatt - smooth - lisa

AR 260-18 18 cm / 7"

AR 260-20 20 cm / 8"

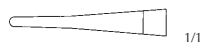

AR 260-18

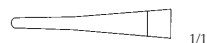

AR 260-20

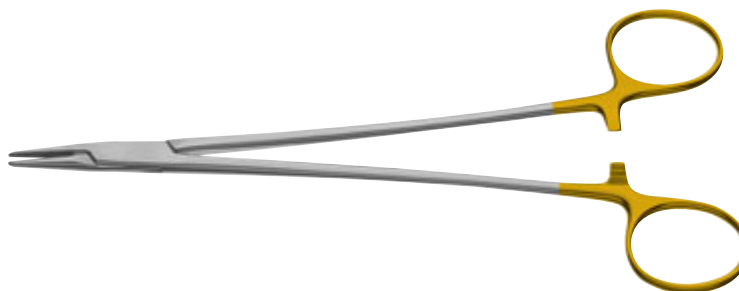

**DeBakey**

gerieft T04 - serrated P04 - estriada P04

AR 270-15 15 cm / 6"

AR 270-18 18 cm / 7"

AR 270-20 20 cm / 8"

AR 270-23 23 cm / 9"

AR 270-26 26 cm / 10¼"

AR 270-30 30 cm / 12"

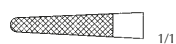

AR 270-15

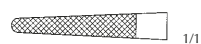

AR 270-18

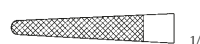

AR 270-20



AR 270-23



AR 270-26



AR 270-30

**Nadelhalter**  
**Needle Holders**  
**Porta-agujas**

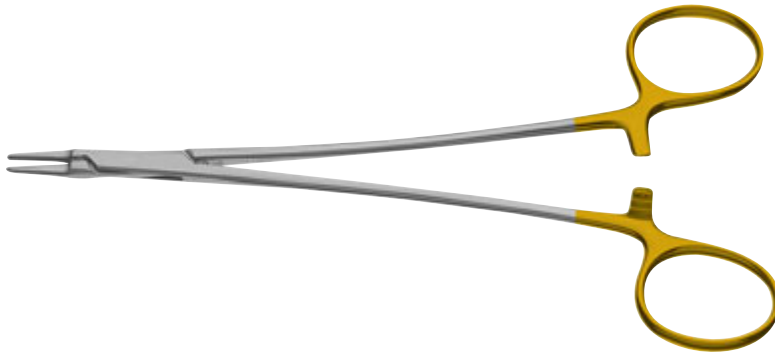

**Mini Ryder**

Breite – width – anchura 1,1 mm  
gerieft T03 - serrated P03 - estriada P03

- AR 280-12** 12 cm / 4¾"
- AR 280-15** 15 cm / 6"
- AR 280-18** 18 cm / 7"
- AR 280-20** 20 cm / 8"
- AR 280-23** 23 cm / 9"

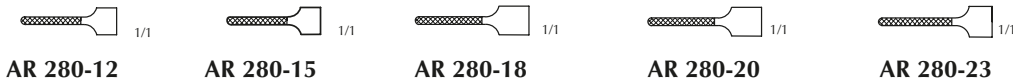

**AR 280-12**      **AR 280-15**      **AR 280-18**      **AR 280-20**      **AR 280-23**

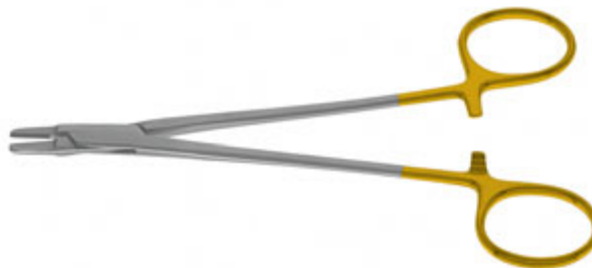

**Ryder**

glatt – smooth – lisa

- AR 284-12** 12 cm / 4¾"
- AR 284-15** 15 cm / 6"
- AR 284-18** 18 cm / 7"
- AR 284-20** 20 cm / 8"
- AR 284-23** 23 cm / 9"



**AR 284-12**      **AR 284-15**      **AR 284-18**      **AR 284-20**      **AR 284-23**

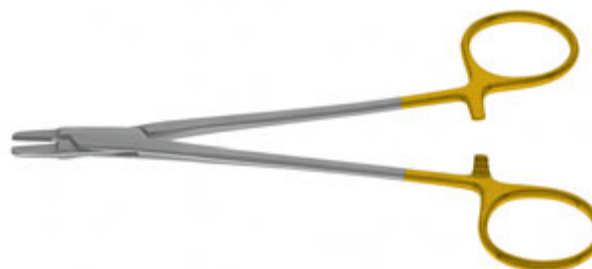

**Ryder**

Breite – width – anchura 1,6 mm  
gerieft T04 - serrated P04 – estriada P04

- AR 286-12** 12 cm / 4¾"
- AR 286-15** 15 cm / 6"
- AR 286-18** 18 cm / 7"
- AR 286-23** 23 cm / 9"
- AR 286-26** 26 cm / 10¼"



**AR 286-12**      **AR 286-15**      **AR 286-18**      **AR 286-23**      **AR 286-26**

GEOMED GOLD-GRIP®

**Nadelhalter**  
**Needle Holders**  
**Porta-agujas**

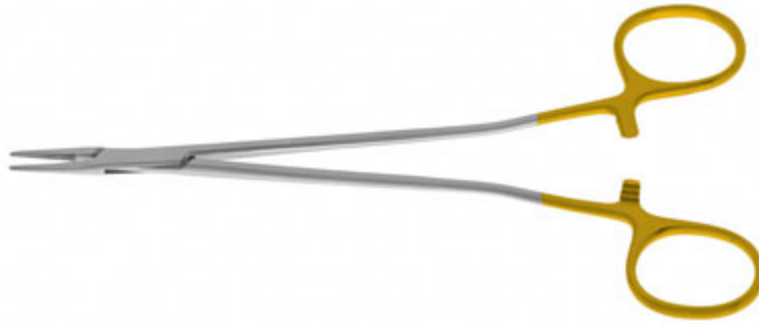

**Hegar-Vascular**

gerieft T02 - serrated P02 - estriada P02

AR 290-14 14 cm / 5½"

AR 290-18 18 cm / 7"

AR 290-20 20 cm / 8"

AR 290-23 23 cm / 9"



AR 290-14



AR 290-18



AR 290-20



AR 290-23

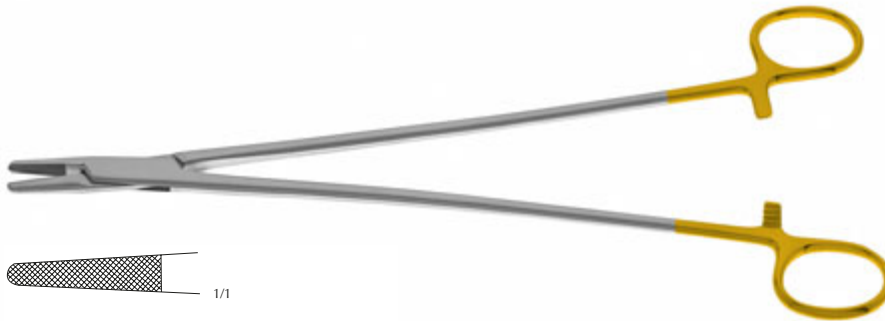

**Masson**

gerieft T05 - serrated P05 - estriada P05

AR 292-27 27 cm / 10¾"



AR 292-27



**Wangenstein**

gerieft T05 - serrated P05 - estriada P05

AR 320-27 27 cm / 10¾"



AR 320-27

**Nadelhalter**  
**Needle Holders**  
**Porta-agujas**

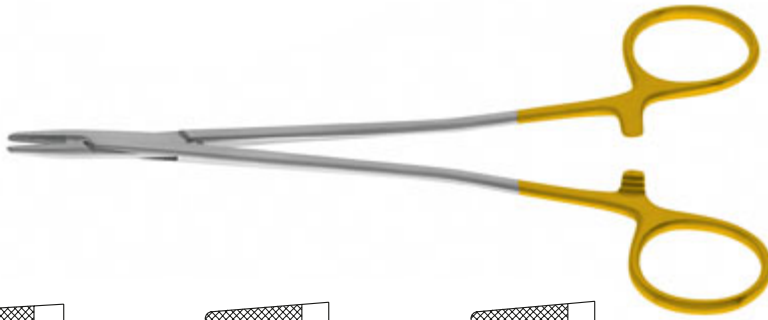

**Sarot**

gerieft T05 - serrated P05 - estriada P05

**AR 390-18** 18 cm / 7"

**AR 390-20** 20 cm / 8"

**AR 390-26** 26 cm / 10¼"



**AR 390-18**



**AR 390-20**



**AR 390-26**



**Stratte**

gerieft T05 - serrated P05 - estriada P05

**AR 421-21** 21 cm / 8¼"

**AR 421-24** 24 cm / 9½"

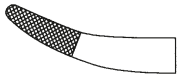

**AR 421-21**

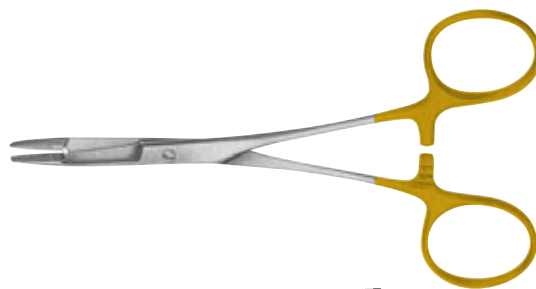

**Olsen-Hegar**

gerieft T04 - serrated P04 - estriada P04

**AR 500-14** 14 cm / 5½"

**AR 500-18** 18 cm / 7"

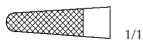

**AR 500-14**

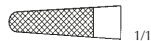

**AR 500-18**



**Gillies**

gerieft T04 - serrated P04 - estriada P04

**AR 511-16** 16 cm / 6¼"





GEOMED **GOLD-GRIP<sup>®</sup>**

**Nadelhalter**  
**Needle Holders**  
**Porta-agujas**

**Mathieu**

Innensperre - interior ratchet - cierre interior

gerieft T05 - serrated P05 - estriada P05

**AR 600-17** 17 cm / 6<sup>3</sup>/<sub>4</sub>"

**AR 600-20** 20 cm / 8"



**AR 600-17**

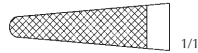

**AR 600-20**

**Mathieu**

schmales Maul - narrow jaw - boca estrecha

gerieft T05 - serrated P05 - estriada P05

**AR 620-14** 14 cm / 5<sup>1</sup>/<sub>2</sub>"

**AR 620-17** 17 cm / 6<sup>3</sup>/<sub>4</sub>"

**AR 620-20** 20 cm / 8"

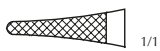

**AR 620-14**

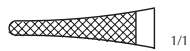

**AR 620-17**

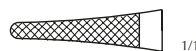

**AR 620-20**

**Mathieu**

gerieft T05 - serrated P05 - estriada P05

**AR 630-14** 14 cm / 5<sup>1</sup>/<sub>2</sub>"

**AR 630-17** 17 cm / 6<sup>3</sup>/<sub>4</sub>"

**AR 630-20** 20 cm / 8"

**AR 630-24** 24 cm / 9<sup>1</sup>/<sub>2</sub>"

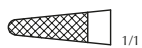
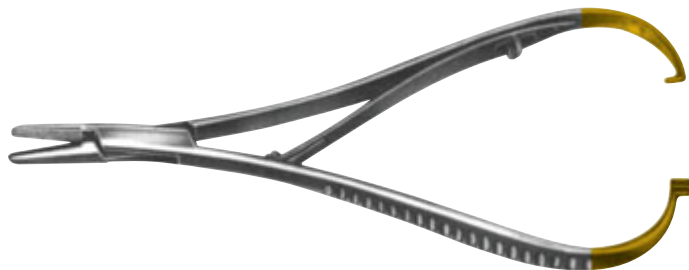

**AR 630-14**



**AR 630-17**



**AR 630-20**

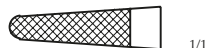

**AR 630-24**

**Skalpellgriffe**

**Scalpel Handles**

**Mangos de bisturías**



# 3  
AS 100-03

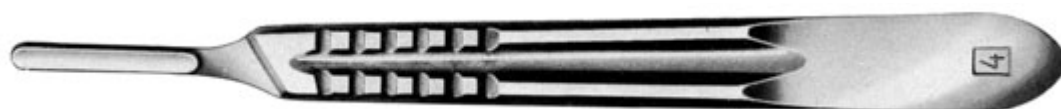

# 4  
AS 100-04



# 7  
AS 100-07



# 3L  
AS 110-03



# 4L  
AS 110-04

**Skalpellgriffe**  
**Scalpel Handles**  
**Mangos de bisturías**



**Hardy**

Vertikal – vertical - vertical  
AS 111-24 24 cm / 9½"



**Hardy**

Lateral – lateral – lateral  
AS 113-24 24 cm / 9½"



**# 3**

mit Skala – with scale – con escala  
AS 115-03

**Hirnmesser, Seziermesser und Organmesser**  
**Brain knives, Autopsy knives, Post Mortem Knives**  
**Cuchillos para autopsía, cerebro y órganos**

Längenangabe = Schnittlänge  
Length indication = Length of blade  
indicación de longitud = longitud de corte



**Virchow**

Hirnmesser mit Hohlheft  
Brain knives with hollow handle  
Cuchillos para cerebro con mango hueco

**AS 280-16** 16 cm / 6¼"

**AS 280-20** 20 cm / 8"

**AS 280-24** 24 cm / 9½"



**Virchow**

Seziermesser mit Metallheft  
Autopsy Knife with metal handle  
Cuchillo para autopsia con mango metálico

**AS 310-09** 9 cm / 3½"



Seziermesser mit Metallheft  
Autopsy Knife with metal handle  
Cuchillo para autopsia con mango metálico

**AS 320-20** 20 cm / 8"



Organmesser mit Holzheft  
Post mortem Knife with wooden handle  
Cuchillo para órganos con mango de madera

**AS 400-11** 11 cm / 4¼"

## Organmesser und Knorpelmesser Post Mortem Knives, Cartilage Knives Cuchillos para órganos y cartílago

Längenangabe = Schnittlänge  
Length indication = Length of blade  
indicación de longitud = longitud de corte



Organmesser mit Metallheft  
Post mortem Knife with metal handle  
Cuchillo para órganos con mango metálico  
**AS 410-10** 10,0 cm / 4"



Knorpelmesser mit Metallheft  
Cartilage Knife with metal handle  
Cuchillo para cartílago con mango metálico  
**AS 430-55** 5,5 cm / 2 1/8"



Knorpelmesser mit Holzheft  
Cartilage Knife with wooden handle  
Cuchillo para cartílago con mango de madera  
**AS 440-70** 7 cm / 2 3/4"

**Saugrohre**  
**Suction Tubes**  
**Tubos de aspiración**



**Adson**

21 cm / 8½"

gebogen - curved - curvo

**AT 101-12** ø 4 mm

**AT 101-15** ø 5 mm



**Plester**

19,5 cm / 7¼"

**AT 111-04** ø 1,5 mm

**AT 111-06** ø 2 mm

**AT 111-08** ø 2,7 mm

**AT 111-10** ø 3,3 mm



**Frazier**

19 cm / 7½"

**AT 121-06** ø 2 mm

**AT 121-08** ø 2,7 mm

**AT 121-10** ø 3,3 mm

**AT 121-12** ø 4 mm

**AT 121-15** ø 5 mm



**Fergusson**

17 cm / 6¾"

**AT 125-06** ø 2 mm

**AT 125-08** ø 2,7 mm

**AT 125-10** ø 3,3 mm

**AT 125-12** ø 4 mm

**AT 125-15** ø 5 mm



**Frazier**

Ventrikelkanüle, gerade  
ventricular cannula, straight  
canula ventricular, recta

12 cm / 4¾"

**AT 130-01** ø 1 mm

**AT 130-02** ø 2 mm

**AT 130-03** ø 3 mm

**Saugrohre**  
**Suction Tubes**  
**Tubos de aspiración**

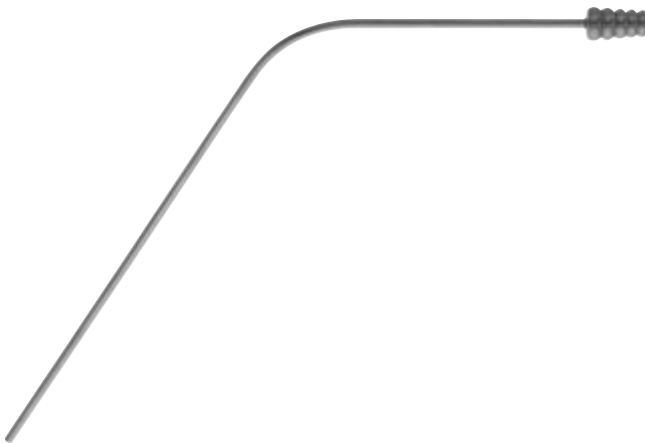

**Yasargil**

21,5 cm / 8<sup>3</sup>/<sub>4</sub>"

<b>AT 140-15</b>	ø 1,5 mm
<b>AT 140-20</b>	ø 2 mm
<b>AT 140-25</b>	ø 2,5 mm
<b>AT 140-35</b>	ø 3,5 mm



**Baron**

14,5 cm / 5<sup>3</sup>/<sub>4</sub>"

<b>AT 161-03</b>	ø 1 mm
<b>AT 161-05</b>	ø 1,7 mm
<b>AT 161-07</b>	ø 2,3 mm

17 cm / 6<sup>3</sup>/<sub>4</sub>"

<b>AT 163-03</b>	ø 1 mm
<b>AT 163-05</b>	ø 1,7 mm
<b>AT 163-07</b>	ø 2,3 mm



**House**

14,5 cm / 5<sup>3</sup>/<sub>4</sub>"

<b>AT 165-03</b>	ø 1 mm
<b>AT 165-05</b>	ø 1,7 mm
<b>AT 165-07</b>	ø 2,3 mm
<b>AT 165-10</b>	ø 3,3 mm
<b>AT 165-12</b>	ø 4 mm
<b>AT 165-14</b>	ø 4,7 mm

17 cm / 6<sup>3</sup>/<sub>4</sub>"

<b>AT 167-03</b>	ø 1 mm
<b>AT 167-05</b>	ø 1,7 mm
<b>AT 167-07</b>	ø 2,3 mm
<b>AT 167-10</b>	ø 3,3 mm
<b>AT 167-12</b>	ø 4 mm
<b>AT 167-14</b>	ø 4,7 mm

**Saugrohre**  
**Suction Tubes**  
**Tubos de aspiración**



**Poole**  
22 cm / 8¾"  
gerade - straight - recta  
**AT 170-10**    ø 10 mm



**Poole**  
20 cm / 8"  
gebogen - curved - curva  
**AT 171-05**    ø 5,5 mm

22 cm / 8¾"  
gebogen - curved - curva  
**AT 171-08**    ø 8 mm



**Yankauer**  
komplett - complete - completo  
**AT 200-00**    27 cm / 10½"

bestehend aus - including - compuesto de:

Saugkopf, abschraubbar  
Suction head, detachable  
Punta aspiradora, destornillable  
**AT 201-01**

Olive - oliva - oliva  
**AT 201-02**

Saugrohr mit Griff  
Tube with handle  
Tubo con mango  
**AT 201-03**



**Yankauer**  
Saugrohr mit zentraler Bohrung  
Suction tube with central bore  
Tubo de aspiración con toladro central  
ø 4,8 mm  
**AT 201-05**



**Saugrohre**  
**Suction Tubes**  
**Tubos de aspiración**



**Cooley**  
gebogen - curved - curva  
ø 8 mm  
**AT 251-36** 36 cm / 14½"



ø 9 mm  
gebogen - curved - curva  
**AT 261-30** 30 cm / 12"



ø 8 mm  
**AT 271-30** 30 cm / 12"



ø 8 mm  
**AT 281-32** 32 cm / 12½"

## Saugrohre

## Suction Tubes

## Tubos de aspiración

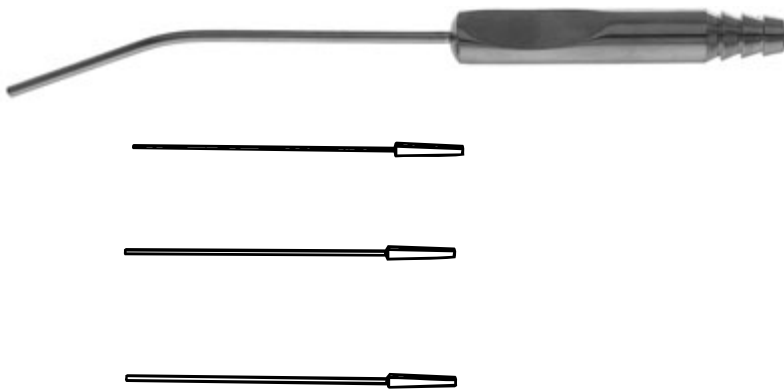

### Wullstein

komplett mit 3 Aufsätzen

complete with 3 tips

completo con 3 puntas

**AT 360-00** 14 cm / 5½"



### Mikroaugkanüle

Micro Suction Cannula

Micro tubo de aspiración

4,5 cm / 1¾"

**AT 361-05** 0,5 mm

**AT 361-07** 0,7 mm

**AT 361-09** 0,9 mm

**Trokare**  
**Trocars**  
**Trocares**

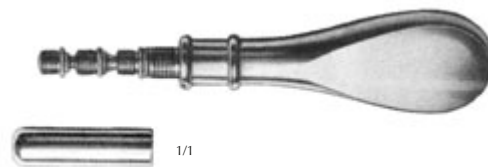

**Universal**

Satz mit 3 Trokaraufsätzen, bestehend aus:  
Set of 3 trocar tips, including:  
Juego de 3 trocar puntas, compuesto de:

- 1 Aufsatz - 1 tip - 1 punta ø 1,7 mm
  - 1 Aufsatz - 1 tip - 1 punta ø 3 mm
  - 1 Aufsatz - 1 tip - 1 punta ø 4,5 mm
- AU 090-03** 12 cm / 4¾"

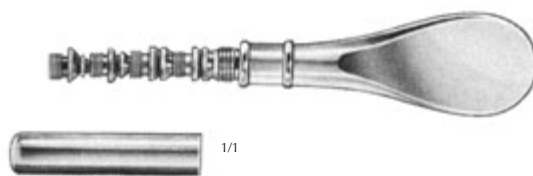

**Universal**

Satz mit 4 Trokaraufsätzen, bestehend aus:  
Set of 4 trocar tips, including:  
Juego de 4 trocar puntas, compuesto de:

- 1 Aufsatz - 1 tip - 1 punta ø 1,7 mm
  - 1 Aufsatz - 1 tip - 1 punta ø 3 mm
  - 1 Aufsatz - 1 tip - 1 punta ø 4,5 mm
  - 1 Aufsatz - 1 tip - 1 punta ø 6 mm
- AU 090-04** 13 cm / 5"

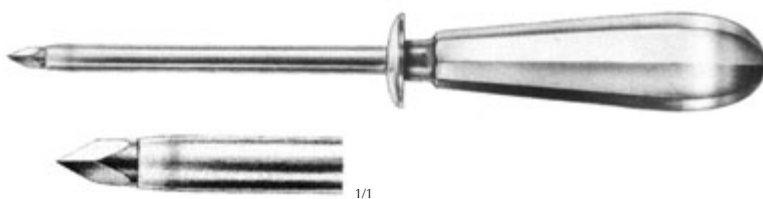

**Nelson**

ø 7,5 mm  
**AU 100-07** 21 cm / 8¼"



**Nelson**

ø 9,5 mm  
**AU 100-09** 21 cm / 8¼"



**Nelson**

ø 11 mm  
**AU 100-11** 21 cm / 8¼"

**Trokare**  
**Trocars**  
**Trocares**



- Standard**  
 ø 3 mm  
**AU 110-03** 18 cm / 7"  
 ø 4 mm  
**AU 110-04** 18 cm / 7"  
 ø 5 mm  
**AU 110-05** 18 cm / 7"  
 ø 6 mm  
**AU 110-06** 18 cm / 7"



- Standard**  
 mit Hahn - with stopcock - con llave  
 ø 3 mm  
**AU 120-03** 20,5 cm / 8"  
 ø 4 mm  
**AU 120-04** 20,5 cm / 8"  
 ø 5 mm  
**AU 120-05** 20,5 cm / 8"  
 ø 6 mm  
**AU 120-06** 20,5 cm / 8"



- Standard**  
 mit Hahn und Auslauf  
 with stopcock and connecting olive  
 con llave y oliva de conexión  
 ø 3 mm  
**AU 130-03** 20,5 cm / 8"  
 ø 4 mm  
**AU 130-04** 20,5 cm / 8"  
 ø 5 mm  
**AU 130-05** 20,5 cm / 8"  
 ø 6 mm  
**AU 130-06** 20,5 cm / 8"

**Trokare**  
**Trocars**  
**Trocares**



**Ochsner**  
ø 3,5 mm  
**AU 150-03** 14 cm / 5½"

ø 4,5 mm  
**AU 150-04** 14 cm / 5½"

ø 5,5 mm  
**AU 150-05** 14 cm / 5½"

ø 6,5 mm  
**AU 150-06** 14 cm / 5½"

ø 7,5 mm  
**AU 150-07** 14 cm / 5½"

ø 8,5 mm  
**AU 150-08** 14 cm / 5½"

ø 9,5 mm  
**AU 150-09** 14 cm / 5½"



**Duke**  
ø 5,5 mm  
**AU 160-05** 11 cm / 4¼"



**Buelau**  
ø 8 mm  
**AU 220-08** 24 cm / 9½"



**Trokare**  
**Trocars**  
**Trocares**



**Pierce**  
ø 4 mm  
AU 281-04 16 cm / 6¼"



**Lichtwitz**  
ø 1,8 mm  
AU 300-19 19,5 cm / 7¾"



**Coakley**  
ø 2,25 mm  
AU 311-16 16 cm / 6¼"

**Spezialkanülen**  
**Special Needles**  
**Agujas especiales**



**Iowa**  
komplett - complete - completo  
**AU 580-00**

bestehend aus - including - compuesto de:

Trompete - trumpet - trompeta  
**AU 581-01** 14 cm / 5½"

Kanüle - needle - aguja ø 1 mm  
**AU 582-02** 16 cm / 6¼"



Venenkanülen  
Vein Cannulas  
Cánulas para venas  
**AU 590-12** 1,20 mm x 80 mm  
**AU 590-15** 1,50 mm x 80 mm



**Quinke**  
Lumbalpunktion  
Lumbar puncture  
Punción lumbar  
**AU 600-10** 1,2 x 76 mm (18 G X 3")  
**AU 600-12** 1,2 x 90 mm (18 G x 3½")  
**AU 600-14** 1,0 x 76 mm (19 G X 3")  
**AU 600-16** 1,0 x 90 mm (19 G X 3½")  
**AU 600-18** 0,7 x 76 mm (22 G X 3")  
**AU 600-19** 0,7 x 50 mm (22 G X 2")  
**AU 600-20** 0,7 x 90 mm (22 G X 3½")



**Tuohy**  
Lumbalpunktionskanüle  
Lumbar puncture needles  
Aguja para punción lumbar  
**AU 610-10** 1,6 x 76 mm (16 G X 3")  
**AU 610-12** 1,4 x 76 mm (17 G X 3")  
**AU 610-14** 1,2 x 76 mm (18 G X 3")

**Spezialkanülen, Gefäßspülkanülen**  
**Special Needles, Vessel Irrigation Cannulas**  
**Agujas especiales, Cánulas para irrigación vascular**



**Verres**  
Insufflationskanüle  
Insufflation Cannula  
Cánula para insuflación  
**AU 630-20** 2,5 x 150 mm



**Klima-Rossegger**  
Sternalpunktion  
Sternal puncture  
Punción del esternón  
**AU 700-12** 1,2 x 35 mm  
**AU 700-18** 1,8 x 35 mm



**Schmid**  
biegsam – malleable – maleable  
15 cm / 6"  
**AU 760-02** 2 mm  
**AU 760-03** 3 mm  
**AU 760-04** 4 mm  
**AU 760-05** 5 mm  
**AU 760-06** 6 mm



**Mock**  
Heparinnadel  
Heparin Flushing Needle  
Aguja para heparin  
**AU 770-06** 6,5 cm / 2½"

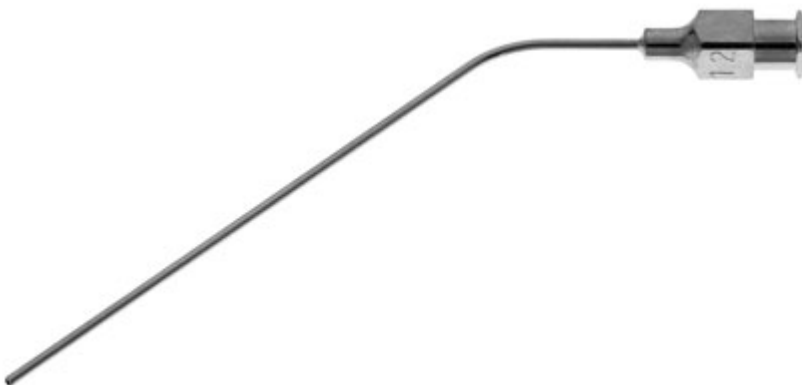

**Rosen**  
mit Luer Lock Ansatz  
with Luer Lock connection  
con conexión Luer Lock  
**AU 791-05** Ø 0,5 mm  
**AU 791-06** Ø 0,6 mm  
**AU 791-07** Ø 0,7 mm  
**AU 791-08** Ø 0,8 mm  
**AU 791-09** Ø 0,9 mm  
**AU 791-10** Ø 1,0 mm  
**AU 791-12** Ø 1,2 mm  
**AU 791-14** Ø 1,4 mm  
**AU 791-15** Ø 1,5 mm  
**AU 791-18** Ø 1,8 mm  
**AU 791-20** Ø 2,0 mm  
**AU 791-25** Ø 2,5 mm  
**AU 791-30** Ø 3,0 mm



**Wund- und Blasenspritzen**  
**Wound and bladder syringes**  
**Jeringas para enjuagar la vejiga y heridas**



**Janet**

mit 1 konischen und 1 olivenförmigen Aufsatz  
with 1 conical tip and 1 bulbous tip  
con 1 punta cónica y 1 punta forma oliva

<b>AU 800-05</b>	50 ml
<b>AU 800-10</b>	100 ml
<b>AU 800-15</b>	150 ml
<b>AU 800-20</b>	200 ml



konischer Aufsatz – conical tip – punta cónica  
**AU 801-01**



olivenförmiger Aufsatz – bulbous tip –  
punta forma oliva  
**AU 801-02**

**Sonden**  
**Probes**  
**Estiletos**



Knopfsonden  
Button-end probes  
Estiletos abotonados

ø 1 mm

<b>AW 090-11</b>	11,5 cm / 4½"
<b>AW 090-13</b>	13 cm / 5"
<b>AW 090-14</b>	14,5 cm / 5¾"
<b>AW 090-16</b>	16 cm / 6¼"
<b>AW 090-18</b>	18 cm / 7"
<b>AW 090-20</b>	20 cm / 8"



Knopfsonden  
Button-end probes  
Estiletos abotonados

ø 1,5 mm

<b>AW 100-11</b>	11,5 cm / 4½"
<b>AW 100-13</b>	13 cm / 5"
<b>AW 100-14</b>	14,5 cm / 5¾"
<b>AW 100-16</b>	16 cm / 6¼"
<b>AW 100-18</b>	18 cm / 7"
<b>AW 100-20</b>	20 cm / 8"
<b>AW 100-25</b>	25 cm / 10"



Knopfsonden  
Button-end probes  
Estiletos abotonados

ø 2 mm

<b>AW 110-11</b>	11,5 cm / 4½"
<b>AW 110-13</b>	13 cm / 5"
<b>AW 110-14</b>	14,5 cm / 5¾"
<b>AW 110-16</b>	16 cm / 6¼"
<b>AW 110-18</b>	18 cm / 7"
<b>AW 110-20</b>	20 cm / 8"
<b>AW 110-25</b>	25 cm / 10"

**Sonden**  
**Probes**  
**Estiletos**



Knopfsonden mit Ohr  
Button-end probes with eye  
Estiletos abotonados con ojo

ø 2 mm

<b>AW 120-13</b>	13 cm / 5"
<b>AW 120-14</b>	14,5 cm / 5¾"
<b>AW 120-16</b>	16 cm / 6¼"
<b>AW 120-18</b>	18 cm / 7"
<b>AW 120-20</b>	20 cm / 8"
<b>AW 120-25</b>	25 cm / 10"



Hohlsonden  
Grooved directors  
Estiletos acanalados

<b>AW 150-11</b>	11,5 cm / 4½"
<b>AW 150-13</b>	13 cm / 5"
<b>AW 150-14</b>	14,5 cm / 5¾"
<b>AW 150-16</b>	16 cm / 6¼"
<b>AW 150-18</b>	18 cm / 7"
<b>AW 150-20</b>	20 cm / 8"



**Doyen**  
Hohlsonde, gebogen  
Grooved director, curved  
Estilete acanalado, curvo  
**AW 161-14** 14 cm / 5½"



**Nelaton**  
Hohlsonde, gebogen  
Grooved director, curved  
Estilete acanalado, curvo  
**AW 171-16** 16 cm / 6¼"

**Sonden**  
**Probes**  
**Estiletos**



Geknöpft Hohlsonden  
 Grooved button-end directors  
 Estiletos acanalados y abotonados  
**AW 180-13** 13 cm / 5"  
**AW 180-14** 14,5 cm / 5¾"  
**AW 180-16** 16 cm / 6¼"



**Fish**  
 Knopfsonden  
 Button-end probes  
 Estiletos abotonados  
 ø 2 mm  
**AW 200-14** 14 cm / 5½"  
**AW 200-18** 18 cm / 7"



**Stacke**  
**AW 220-10** 10,5 cm / 4¼"



Geknöpft Myrtenblattsonde  
 Button-end myrtle leaf probe  
 Estiletos abotonados hoja de mirto  
**AW 230-13** 13 cm / 5"  
**AW 230-14** 14,5 cm / 5¾"  
**AW 230-16** 16 cm / 6¼"  
**AW 230-20** 20 cm / 8"



**Lockhart-Mummery**  
 Fistelsonden  
 Fistula Probes  
 Sondas para fistula  
 16,5 cm / 6½"

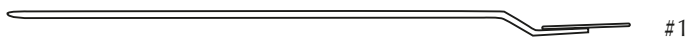

**AW 240-01** # 1



**AW 240-02** # 2

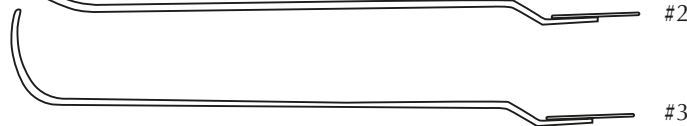

**AW 240-03** # 3

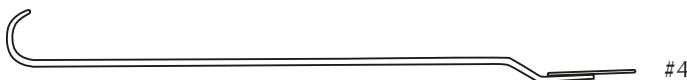

**AW 240-04** # 4

**Watteträger**  
**Cotton Applicators**  
**Porta-algodones**



**Farrell (Lathbury-Uebe)**

*rund, gerieft*  
*round, serrated*  
*ronda, estriada*

ø 0,9 mm

**AW 300-12** 12 cm / 4¾"

**AW 300-14** 14 cm / 5½"

ø 1,1 mm

**AW 300-16** 16 cm / 6¼"

ø 1,2 mm

**AW 300-18** 18 cm / 7"

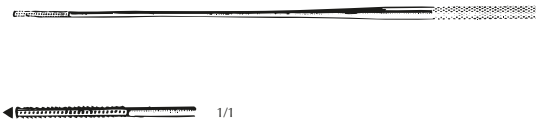

**Farrell**

*Dreikant, gerieft*  
*Triangular, serrated*  
*Triangular, estriada*

ø 0,9 mm

**AW 310-12** 12 cm / 4¾"

**AW 310-14** 14 cm / 5½"

ø 1,1 mm

**AW 310-16** 16 cm / 6¼"

ø 1,2 mm

**AW 310-18** 18 cm / 7"



**Farrell**

*Dreikant, glatt*  
*Triangular, smooth*  
*Triangular, lisa*

ø 1,5 mm

**AW 320-12** 12 cm / 4¾"

**AW 320-14** 14 cm / 5½"

**AW 320-16** 16 cm / 6¼"

**AW 320-18** 18 cm / 7"

**Wundhäkchen**  
**Hooks**  
**Ganchos**



**Kilner**  
 scharf - sharp - agudo  
**AX 004-01** 15 cm / 6"

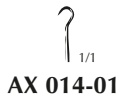

**Gillies**  
 klein - small - pequeño  
**AX 014-01** 18 cm / 7"

groß - large - grande  
**AX 014-02** 18 cm / 7"



# 1  
 scharf - sharp - agudo  
**AX 034-01** 16 cm / 6 1/4"



# 2  
 scharf - sharp - agudo  
**AX 034-02** 16 cm / 6 1/4"

# 3  
 scharf - sharp - agudo  
**AX 034-03** 16 cm / 6 1/4"

# 4  
 scharf - sharp - agudo  
**AX 034-04** 16 cm / 6 1/4"

**Wundhäkchen**  
**Hooks**  
**Ganchos**



**Graefe**

stumpf - blunt - romo

**AX 040-16** 16 cm / 6¼"



**AX 040-16** 1/1



**AX 044-16** 1/1

scharf - sharp - agudo

**AX 044-16** 16 cm / 6¼"



**Rollet**

4-zahnig - 4 prongs - 4 dientes

stumpf - blunt - romos

**AX 050-04** 13 cm / 5"



**AX 050-04** 1/1



**AX 054-04** 1/1

scharf - sharp - agudos

**AX 054-04** 13 cm / 5"



**Guthrie**

2-zahnig - 2 prongs - 2 dientes

scharf - sharp - agudos

*klein - small - pequeño*

**AX 094-01** 16 cm / 6¼"



**AX 094-01** 1/1



**AX 094-02** 1/1

*groß - large - grande*

**AX 094-02** 16 cm / 6¼"

## Wundhäkchen

### Hooks

### Ganchos



*feines Modell - fine pattern - modelo delgado*  
stumpf - blunt - romo

1-zahnig - 1 prong - 1 diente  
**AX 100-01** 16 cm / 6¼"

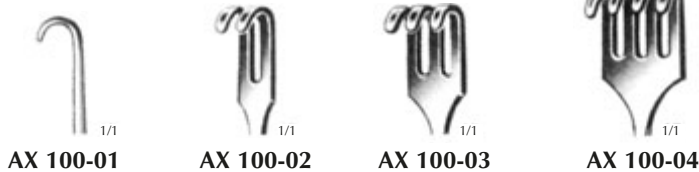

2-zahnig - 2 prongs - 2 dientes  
**AX 100-02** 16 cm / 6¼"

3-zahnig - 3 prongs - 3 dientes  
**AX 100-03** 16 cm / 6¼"

4-zahnig - 4 prongs - 4 dientes  
**AX 100-04** 16 cm / 6¼"



*feines Modell - fine pattern - modelo delgado*  
scharf - sharp - agudo

1-zahnig - 1 prong - 1 diente  
**AX 104-01** 16 cm / 6¼"

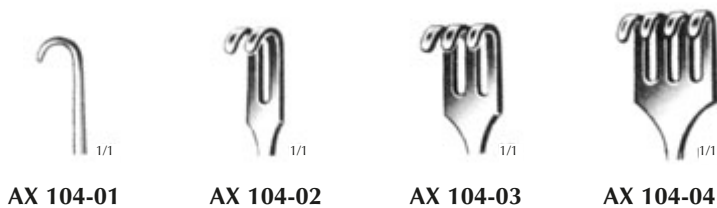

2-zahnig - 2 prongs - 2 dientes  
**AX 104-02** 16 cm / 6¼"

3-zahnig - 3 prongs - 3 dientes  
**AX 104-03** 16 cm / 6¼"

4-zahnig - 4 prongs - 4 dientes  
**AX 104-04** 16 cm / 6¼"



## Wundhäkchen

### Hooks

### Ganchos

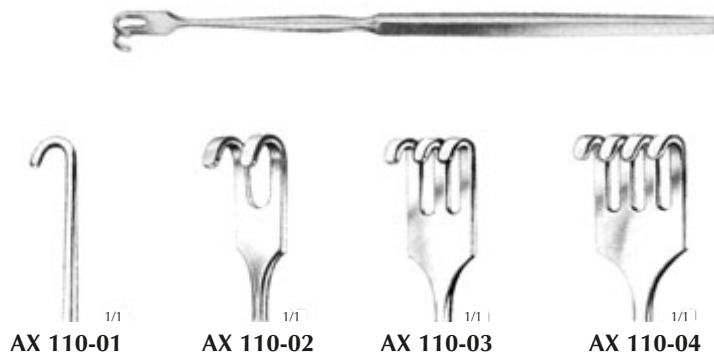

#### Standard

stumpf - blunt - romo

1-zahnig - 1 prong - 1 diente

**AX 110-01**      16 cm / 6¼"

2-zahnig - 2 prongs - 2 dientes

**AX 110-02**      16 cm / 6¼"

3-zahnig - 3 prongs - 3 dientes

**AX 110-03**      16 cm / 6¼"

4-zahnig - 4 prongs - 4 dientes

**AX 110-04**      16 cm / 6¼"

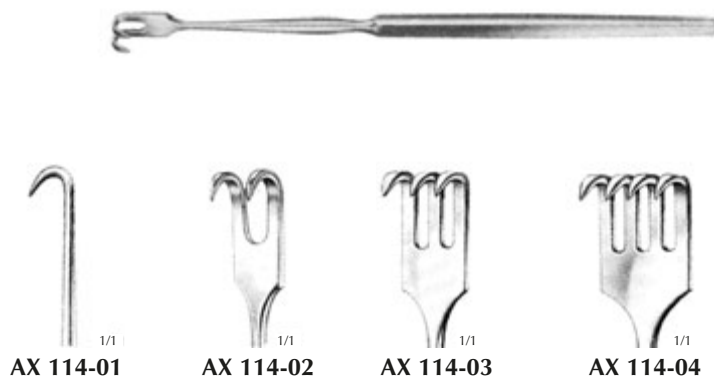

#### Standard

scharf - sharp - agudo

1-zahnig - 1 prong - 1 diente

**AX 114-01**      16 cm / 6¼"

2-zahnig - 2 prongs - 2 dientes

**AX 114-02**      16 cm / 6¼"

3-zahnig - 3 prongs - 3 dientes

**AX 114-03**      16 cm / 6¼"

4-zahnig - 4 prongs - 4 dientes

**AX 114-04**      16 cm / 6¼"

**Wundhaken**

**Retractors**

**Separadores**



*flexibel - flexible - flexible*  
stumpf - blunt - romo

2-zahinig - 2 prongs - 2 dientes  
**AX 130-02** 16 cm / 6¼"

3-zahinig - 3 prongs - 3 dientes  
**AX 130-03** 16 cm / 6¼"

4-zahinig - 4 prongs - 4 dientes  
**AX 130-04** 16 cm / 6¼"



**AX 130-02**



**AX 130-03**



**AX 130-04**



**AX 134-02**



**AX 134-03**



**AX 134-04**

*flexibel - flexible - flexible*  
scharf - sharp - agudo

2-zahinig - 2 prongs - 2 dientes  
**AX 134-02** 16 cm / 6¼"

3-zahinig - 3 prongs - 3 dientes  
**AX 134-03** 16 cm / 6¼"

4-zahinig - 4 prongs - 4 dientes  
**AX 134-04** 16 cm / 6¼"



**Barsky**

scharf - sharp - agudo  
**AX 144-15** 15 cm / 6"



**Senn-Miller**

20 mm x 6 mm  
stumpf - blunt - romo  
**AX 150-03** 16 cm / 6¼"



**AX 150-03**



**AX 154-03**

scharf - sharp - agudo  
**AX 154-03** 16 cm / 6¼"

**Wundhaken  
Retractors  
Separadores**

*Maße der Blätter: Tiefe x Breite*

*Dimensions of blades: Depth x Width*

*Dimensiones de las hojas: Profundidad x Anchura*



**Senn-Green**

10 mm x 6 mm

**AX 160-10** 15 cm / 6"



**AX 160-10**



**AX 160-20**

20 mm x 6 mm

**AX 160-20** 15 cm / 6"



**Mini-Langenbeck**

10 mm x 6 mm

**AX 170-10** 16 cm / 6¼"



**AX 170-10**



**AX 170-17**

17 mm x 5 mm

**AX 170-17** 16 cm / 6¼"

20 mm x 6 mm

**AX 170-20** 16 cm / 6¼"

22 mm x 8 mm

**AX 170-22** 16 cm / 6¼"



**AX 170-20**



**AX 170-22**

**Wundhaken**  
**Retractors**  
**Separadores**

*Maße der Blätter: Tiefe x Breite.*

*Dimensions of blades: Depth x Width.*

*Dimensiones de las hojas: Profundidad x Anchura.*



**Ragnell-Davis**

10 mm x 4 mm / 17 mm x 6 mm

**AX 180-14** 14 cm / 5½"



**Crile**

12 mm x 4 mm / 20 mm x 6 mm

**AX 185-11** 11 cm / 4½"



**Strandell-Stille**

15 mm x 6 mm

glatt - smooth - liso

**AX 190-19** 19 cm / 7½"

gezahnt - serrated - dentado

**AX 194-19** 19 cm / 7½"

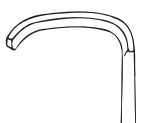

**AX 190-19**



**AX 194-19**

**Wundhaken  
Retractors  
Separadores**



**Desmarres**

Breite - width - anchura 8 mm

**AX 200-08** 14 cm / 5½"

Breite - width - anchura 10 mm

**AX 200-10** 14 cm / 5½"

Breite - width - anchura 12 mm

**AX 200-12** 14 cm / 5½"

Breite - width - anchura 14 mm

**AX 200-14** 14 cm / 5½"

Breite - width - anchura 16 mm

**AX 200-16** 14 cm / 5½"

Breite - width - anchura 18 mm

**AX 200-18** 14 cm / 5½"



**AX 200-08**



**AX 200-10**



**AX 200-12**



**AX 200-14**



**AX 200-16**



**AX 200-18**



**Cushing**

Breite - width - anchura 8,0 mm

**AX 240-08** 20 cm / 8"

Breite - width - anchura 10 mm

**AX 240-10** 20 cm / 8"

Breite - width - anchura 12 mm

**AX 240-12** 20 cm / 8"

Breite - width - anchura 14 mm

**AX 240-14** 20 cm / 8"

Breite - width - anchura 16 mm

**AX 240-16** 20 cm / 8"

Breite - width - anchura 18 mm

**AX 240-18** 20 cm / 8"



**AX 240-08**



**AX 240-10**



**AX 240-12**



**AX 240-14**



**AX 240-16**



**AX 240-18**

**Wundhaken  
Retractors  
Separadores**



**Cushing**

Breite - width - anchura 8 mm

**AX 250-08** 24 cm / 9½"



**AX 250-08**



**AX 250-10**



**AX 250-12**

Breite - width - anchura 10 mm

**AX 250-10** 24 cm / 9½"

Breite - width - anchura 12 mm

**AX 250-12** 24 cm / 9½"



**AX 250-14**



**AX 250-16**



**AX 250-18**

Breite - width - anchura 14 mm

**AX 250-14** 24 cm / 9½"

Breite - width - anchura 16 mm

**AX 250-16** 24 cm / 9½"

Breite - width - anchura 18 mm

**AX 250-18** 24 cm / 9½"



**Gil-Vernet**

biegsamer Schaft – flexible shaft – vástago flexible  
24 cm / 9½"



**AX 262-08**



**AX 262-11**



**AX 262-15**

**AX 262-08** 8 mm

**AX 262-11** 11 mm

**AX 262-15** 15 mm

**AX 262-17** 17 mm

**AX 262-20** 20 mm

**AX 262-23** 23 mm



**AX 262-17**



**AX 262-20**



**AX 262-23**

**Wundhaken  
Retractors  
Separadores**

*Maße der Blätter: Tiefe x Breite.*

*Dimensions of blades: Depth x Width.*

*Dimensiones de las hojas: Profundidad x Anchura.*



**Lahey**

28 mm x 7 mm

**AX 270-20** 20 cm / 8"



**Meyering**

7 mm x 4 mm

**AX 280-07** 18 cm / 7"



**AX 280-07** 1/1



**AX 280-10** 1/1



**AX 280-18** 1/1

7 mm x 4 mm

**AX 280-10** 18 cm / 7"

18 mm x 7 mm

**AX 280-18** 18 cm / 7"



**AX 282-07** 1/1



**AX 282-16** 1/1



**AX 284-03** 1/1

10 mm x 3 mm

**AX 282-07** 18 cm / 7"

16 mm x 5 mm

**AX 282-16** 18 cm / 7"

10 mm x 4 mm

**AX 284-03** 18 cm / 7"



**Volkman**

stumpf - blunt - romo



**AX 300-01** 1/1



**AX 300-02** 1/1



**AX 300-03** 1/1

1-zahnig - 1 prong - 1 diente

**AX 300-01** 21,5 cm / 8½"

2-zahnig - 2 prongs - 2 dientes

**AX 300-02** 21,5 cm / 8½"

3-zahnig - 3 prongs - 3 dientes

**AX 300-03** 21,5 cm / 8½"



**AX 300-04** 1/1

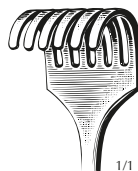

**AX 300-06** 1/1

4-zahnig - 4 prongs - 4 dientes

**AX 300-04** 21,5 cm / 8½"

6-zahnig - 6 prongs - 6 dientes

**AX 300-06** 21,5 cm / 8½"

**Wundhaken**  
**Retractors**  
**Separadores**



**Volkman**  
scharf - sharp - agudo

1-zahnig - 1 prong - 1 diente  
**AX 304-01** 21,5 cm / 8½"

2-zahnig - 2 prongs - 2 dientes  
**AX 304-02** 21,5 cm / 8½"

3-zahnig - 3 prongs - 3 dientes  
**AX 304-03** 21,5 cm / 8½"

4-zahnig - 4 prongs - 4 dientes  
**AX 304-04** 21,5 cm / 8½"

6-zahnig - 6 prongs - 6 dientes  
**AX 304-06** 21,5 cm / 8½"

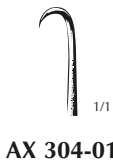

**AX 304-01**



**AX 304-02**



**AX 304-03**



**AX 304-04**



**AX 304-06**



**Volkman**  
stumpf - blunt - romo

1-zahnig - 1 prong - 1 diente  
**AX 320-01** 21,5 cm / 8½"

2-zahnig - 2 prongs - 2 dientes  
**AX 320-02** 21,5 cm / 8½"

3-zahnig - 3 prongs - 3 dientes  
**AX 320-03** 21,5 cm / 8½"

4-zahnig - 4 prongs - 4 dientes  
**AX 320-04** 21,5 cm / 8½"

6-zahnig - 6 prongs - 6 dientes  
**AX 320-06** 21,5 cm / 8½"

8-zahnig - 8 prongs - 8 dientes  
**AX 320-08** 21,5 cm / 8½"



**AX 320-01**



**AX 320-02**



**AX 320-03**



**AX 320-04**



**AX 320-06**

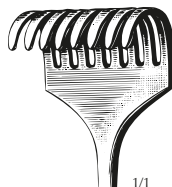

**AX 320-08**



**Wundhaken  
Retractors  
Separadores**



**Volkmann**

halbscharf – semi-sharp –  
semi-agudo

1-zahnig - 1 prong - 1 diente  
**AX 322-01** 21,5 cm / 8½"

2-zahnig - 2 prongs - 2 dientes  
**AX 322-02** 21,5 cm / 8½"

3-zahnig - 3 prongs - 3 dientes  
**AX 322-03** 21,5 cm / 8½"

4-zahnig - 4 prongs - 4 dientes  
**AX 322-04** 21,5 cm / 8½"

6-zahnig - 6 prongs - 6 dientes  
**AX 322-06** 21,5 cm / 8½"

**Volkmann**

scharf - sharp - agudo

1-zahnig - 1 prong - 1 diente  
**AX 324-01** 21,5 cm / 8½"

2-zahnig - 2 prongs - 2 dientes  
**AX 324-02** 21,5 cm / 8½"

3-zahnig - 3 prongs - 3 dientes  
**AX 324-03** 21,5 cm / 8½"

4-zahnig - 4 prongs - 4 dientes  
**AX 324-04** 21,5 cm / 8½"

6-zahnig - 6 prongs - 6 dientes  
**AX 324-06** 21,5 cm / 8½"

8-zahnig - 8 prongs - 8 dientes  
**AX 324-08** 21,5 cm / 8½"

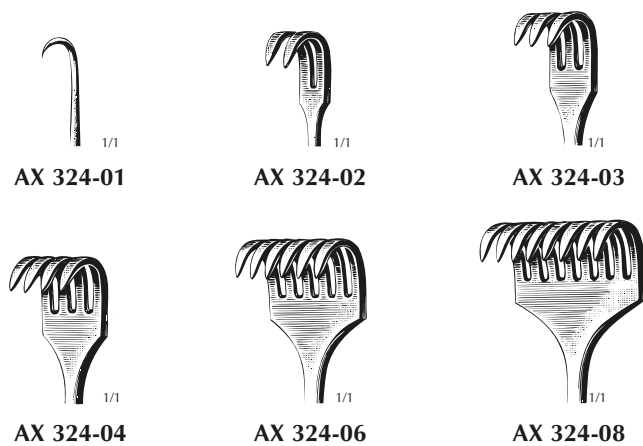
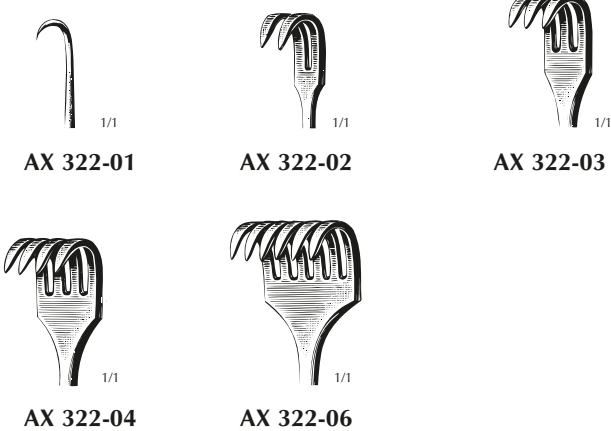

**Wundhaken**  
**Retractors**  
**Separadores**

*Maße der Blätter: Tiefe x Breite.*

*Dimensions of blades: Depth x Width.*

*Dimensiones de las hojas: Profundidad x Anchura*



**Ollier**

3-zahnig - 3 prongs - 3 dientes  
**AX 330-03** 22,5 cm / 8¾"

4-zahnig - 4 prongs - 4 dientes  
**AX 330-04** 22,5 cm / 8¾"



**Israel**

stumpf – blunt – romo  
40 mm x 40 mm

**AX 390-04** 25 cm / 10"

45 mm x 50 mm

**AX 390-05** 25 cm / 10"

50 mm x 60 mm

**AX 390-06** 25 cm / 10"

70 mm x 70 mm

**AX 390-07** 25 cm / 10"



**Kocher**

40 mm x 18 mm

**AX 410-18** 23 cm / 9"

60 mm x 20 mm

**AX 410-20** 23 cm / 9"

60 mm x 25 mm

**AX 410-25** 23 cm / 9"

75 mm x 30 mm

**AX 410-30** 23 cm / 9"

75 mm x 40 mm

**AX 410-40** 23 cm / 9"

**Wundhaken**  
**Retractors**  
**Separadores**

*Maße der Blätter: Tiefe x Breite.*

*Dimensions of blades: Depth x Width.*

*Dimensiones de las hojas: Profundidad x Anchura.*



**Kocher-Langenbeck**

25 mm x 6 mm

**AX 420-01** 21 cm / 8¼"

35 mm x 8 mm

**AX 420-02** 21 cm / 8¼"

35 mm x 11 mm

**AX 420-03** 21 cm / 8¼"

35 mm x 15 mm

**AX 420-04** 21 cm / 8¼"

40 mm x 11 mm

**AX 420-05** 21 cm / 8¼"

55 mm x 11 mm

**AX 420-06** 21 cm / 8¼"

70 mm x 14 mm

**AX 420-07** 21 cm / 8¼"

80 mm x 12 mm

**AX 420-08** 21 cm / 8¼"

80 mm x 16 mm

**AX 420-09** 21 cm / 8¼"

**Wundhaken**  
**Retractors**  
**Separadores**

*Maße der Blätter: Tiefe x Breite.*

*Dimensions of blades: Depth x Width.*

*Dimensiones de las hojas: Profundidad x Anchura*



**Langenbeck**  
mit Hohlheft - with hollow handle -  
con mango hueco

30 mm x 11 mm  
**AX 430-01** 22,5 cm / 8¾"

30 mm x 14 mm  
**AX 430-02** 22,5 cm / 8¾"

30 mm x 16 mm  
**AX 430-03** 22,5 cm / 8¾"

40 mm x 11 mm  
**AX 430-04** 22,5 cm / 8¾"

50 mm x 11 mm  
**AX 430-05** 22,5 cm / 8¾"



**Langenbeck**  
30 mm x 11 mm  
**AX 450-01** 21 cm / 8¼"

30 mm x 14 mm  
**AX 450-02** 21 cm / 8¼"

30 mm x 16 mm  
**AX 450-03** 21 cm / 8¼"

40 mm x 11 mm  
**AX 450-04** 21 cm / 8¼"

50 mm x 11 mm  
**AX 450-05** 21 cm / 8¼"

**Wundhaken  
Retractors  
Separadores**

*Maße der Blätter: Tiefe x Breite.*

*Dimensions of blades: Depth x Width.*

*Dimensiones de las hojas: Profundidad x Anchura*



**Langenbeck**

63 mm x 20 mm

**AX 452-01** 21 cm / 8¼"



85 mm x 15 mm

**AX 452-02** 21 cm / 8¼"



**Hoesel**

60 mm x 20 mm

**AX 456-01** 25 cm / 10"

80 mm x 30 mm

**AX 456-02** 25 cm / 10"

100 mm x 30 mm

**AX 456-03** 25 cm / 10"

120 mm x 30 mm

**AX 456-04** 25 cm / 10"

140 mm x 30 mm

**AX 456-05** 25 cm / 10"

140 mm x 40 mm

**AX 456-06** 25 cm / 10"

**Wundhaken**  
**Retractors**  
**Separadores**

*Maße der Blätter: Tiefe x Breite.*

*Dimensions of blades: Depth x Width.*

*Dimensiones de las hojas: Profundidad x Anchura*



**Obwegeser**

25 mm x 7 mm

**AX 490-25** 22 cm / 8¾"

31 mm x 10 mm

**AX 490-30** 22 cm / 8¾"

42 mm x 11 mm

**AX 490-40** 22 cm / 8¾"

55 mm x 12 mm

**AX 490-55** 22 cm / 8¾"

70 mm x 14 mm

**AX 490-70** 22 cm / 8¾"

80 mm x 16 mm

**AX 490-80** 22 cm / 8¾"



**Obwegeser**

25 mm x 7 mm

**AX 492-25** 22 cm / 8¾"

31 mm x 10 mm

**AX 492-30** 22 cm / 8¾"

42 mm x 11 mm

**AX 492-40** 22 cm / 8¾"

55 mm x 12 mm

**AX 492-55** 22 cm / 8¾"

70 mm x 14 mm

**AX 492-70** 22 cm / 8¾"

80 mm x 16 mm

**AX 492-80** 22 cm / 8¾"

**Wundhaken**  
**Retractors**  
**Separadores**

*Maße der Blätter: Tiefe x Breite*

*Dimensions of blades: Depth x Width*

*Dimensiones de las hojas: Profundidad x Anchura*



**Kocher**

19 mm x 12 mm

**AX 500-01** 22 cm / 8<sup>3</sup>/<sub>4</sub>"

21 mm x 14 mm

**AX 500-02** 22 cm / 8<sup>3</sup>/<sub>4</sub>"

40 mm x 10 mm

**AX 500-03** 22 cm / 8<sup>3</sup>/<sub>4</sub>"

40 mm x 15 mm

**AX 500-04** 22 cm / 8<sup>3</sup>/<sub>4</sub>"

40 mm x 20 mm

**AX 500-05** 22 cm / 8<sup>3</sup>/<sub>4</sub>"



**Meyering**

50 mm x 16 mm

**AX 510-01** 20 cm / 8"

75 mm x 25 mm

**AX 510-02** 23 cm / 9"

90 mm x 50 mm

**AX 510-03** 24 cm / 9<sup>1</sup>/<sub>2</sub>"

**Wundhaken**  
**Retractors**  
**Separadores**

*Maße der Blätter: Tiefe x Breite*

*Dimensions of blades: Depth x Width*

*Dimensiones de las hojas: Profundidad x Anchura*



**Middeldorpf**

16 mm x 14 mm

**AX 520-01** 21,5 cm / 8½"

22 mm x 21 mm

**AX 520-02** 22 cm / 8¾"

30 mm x 30 mm

**AX 520-03** 23,5 cm / 9½"



**Middeldorpf**

45 mm x 45 mm

**AX 550-01** 25,5 cm / 10"

45 mm x 50 mm

**AX 550-02** 25,5 cm / 10"

55 mm x 70 mm

**AX 550-03** 25,5 cm / 10"



**Coryllos**

82 mm x 22 mm

**AX 560-01** 24 cm / 9½"

108 mm x 43 mm

**AX 560-02** 24 cm / 9½"

115 mm x 65 mm

**AX 560-03** 24 cm / 9½"



**Wundhaken**  
**Retractors**  
**Separadores**

*Maße der Blätter: Tiefe x Breite*

*Dimensions of blades: Depth x Width*

*Dimensiones de las hojas: Profundidad x Anchura*



**Fritsch**

Blatt seitlich abgesetzt  
blade set off on side  
hoja vuelta de lado

35 mm x 40 mm

**AX 580-01** 24 cm / 9½"

40 mm x 50 mm

**AX 580-02** 24 cm / 9½"

45 mm x 60 mm

**AX 580-03** 24 cm / 9½"

45 mm x 75 mm

**AX 580-04** 24 cm / 9½"

65 mm x 85 mm

**AX 580-05** 24 cm / 9½"

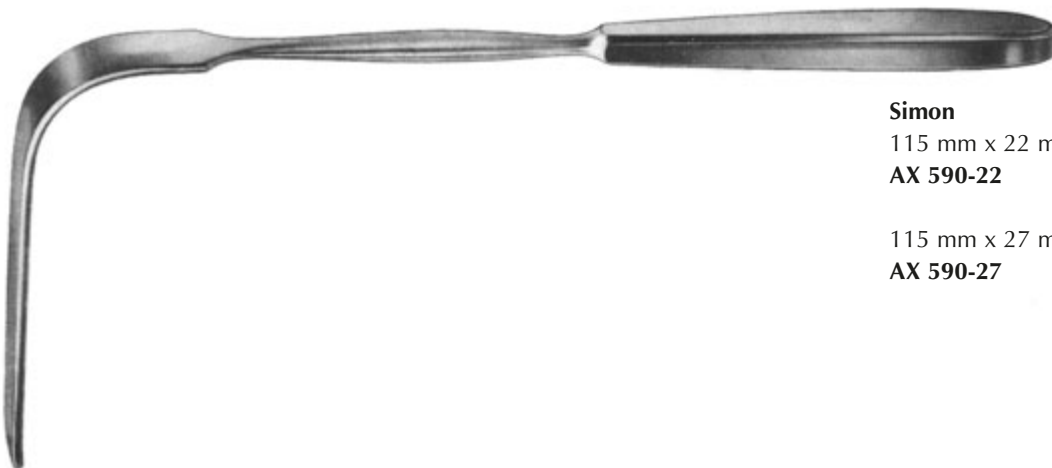

**Simon**

115 mm x 22 mm

**AX 590-22** 28 cm / 11"

115 mm x 27 mm

**AX 590-27** 28 cm / 11"

**Wundhaken**  
**Retractors**  
**Separadores**

*Maße der Blätter: Tiefe x Breite*

*Dimensions of blades: Depth x Width*

*Dimensiones de las hojas: Profundidad x Anchura*

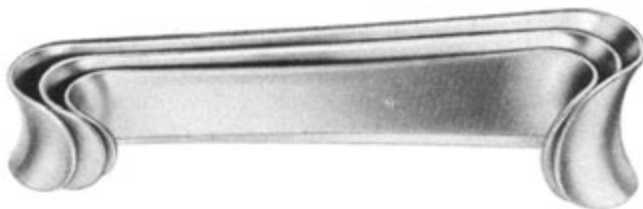

**Roux**

Satz - Set - Juego # 1 - 3

**AX 600-00** 16,5 cm / 6½"

bestehend aus – including – compuesto de:

1 x 23 mm x 21 mm / 28 mm x 29 mm

1 x 26 mm x 26 mm / 31 mm x 37 mm

1 x 29 mm x 30 mm / 35 mm x 42 mm



**Baby-Roux**

17 mm x 16 mm / 20 mm x 21 mm

**AX 601-02** 13 cm / 5¼"



**Parker**

Satz - Set - Juego # 1 - 2

**AX 610-00** 14 cm / 5½"

bestehend aus – including – compuesto de:

1 x 18 mm x 16 mm / 18 x 16 mm

1 x 22 mm x 16 mm / 22 x 16 mm

## Wundhaken Retractors Separadores

*Maße der Blätter: Tiefe x Breite*

*Dimensions of blades: Depth x Width*

*Dimensiones de las hojas: Profundidad x Anchura*



### Collin

Satz - Set - Juego

**AX 620-00** 15 cm / 6"

bestehend aus – including – compuesto de:

1 x 21 mm x 14 mm / 28 mm x 16 mm

1 x 17 mm x 14 mm / 32 mm x 16 mm



### Parker Langenbeck (US-Army)

Satz - Set - Juego # 1 - 2

**AX 630-00** 21 cm / 8¼"

bestehend aus – including – compuesto de:

1 x 24 mm x 15 mm / 37 mm x 15 mm

1 x 29 mm x 15 mm / 42 mm x 15 mm



### Collin-Hartmann

38 mm x 28 mm / 32 mm x 21 mm

**AX 640-01** 14 cm / 5½"

52 mm x 34 mm / 36 mm x 27 mm

**AX 640-02** 16 cm / 6¼"



### Mathieu

Satz - Set - Juego

**AX 642-00** 20 cm / 8"

bestehend aus – including – compuesto de:

1 x 42 mm x 13 mm / 42 mm x 26 mm

1 x 47 mm x 13 mm / 46 mm x 26 mm

**Wundhaken**  
**Retractors**  
**Separadores**

*Maße der Blätter: Tiefe x Breite*

*Dimensions of blades: Depth x Width*

*Dimensiones de las hojas: Profundidad x Anchura*



**Czerny**

38 mm x 22 mm / 38 mm x 22 mm  
AX 644-17 17,5 cm / 6¾"



**Heaney**

45 mm x 25 mm  
AX 646-01 27 cm / 10¾"

73 mm x 28 mm  
AX 646-02 27 cm / 10¾"

82 mm x 28 mm  
AX 646-03 27 cm / 10¾"

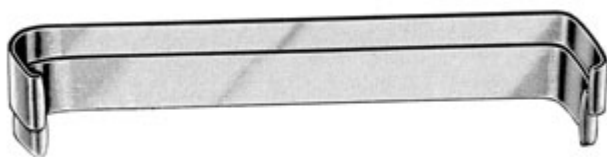

**Farabeuf**

Satz - Set - Juego # 1 - 2  
AX 660-00 15 cm / 6"  
bestehend aus – including – compuesto de

1 x 18 mm x 16 mm / 23 mm x 16 mm  
1 x 22 mm x 16 mm / 28 mm x 16 mm



**Farabeuf**

Satz - Set - Juego # 1 - 2  
AX 665-00 12 cm / 4¾"  
bestehend aus – including – compuesto de

1 x 23 mm x 10 mm / 29 mm x 13 mm  
1 x 26 mm x 10 mm / 33 mm x 13 mm

**Wundhaken  
Retractors  
Separadores**

*Maße der Blätter: Tiefe x Breite*

*Dimensions of blades: Depth x Width*

*Dimensiones de las hojas: Profundidad x Anchura*



**Richardson-Eastman**

Satz - Set - Juego # 1 - 2

**AX 670-00**

klein - small - pequeño # 1

25 mm x 21 mm / 30 mm x 30 mm

**AX 670-01** 26 cm / 10<sup>1</sup>/<sub>4</sub>"

groß - large - grande # 2

38 mm x 38 mm / 65 mm x 43 mm

**AX 670-02** 28 cm / 11"



**Richardson**

25 mm x 20 mm

**AX 680-01** 24 cm / 9<sup>1</sup>/<sub>2</sub>"

30 mm x 27 mm

**AX 680-02** 24 cm / 9<sup>1</sup>/<sub>2</sub>"

38 mm x 38 mm

**AX 680-03** 24 cm / 9<sup>1</sup>/<sub>2</sub>"

50 mm x 20 mm

**AX 680-04** 24 cm / 9<sup>1</sup>/<sub>2</sub>"

**Wundhaken**  
**Retractors**  
**Separadores**

*Maße der Blätter: Tiefe x Breite*

*Dimensions of blades: Depth x Width*

*Dimensiones de las hojas: Profundidad x Anchura*



**Kelly**

50 mm x 40 mm

**AX 690-01** 26 cm / 10¼"

65 mm x 50 mm

**AX 690-02** 26 cm / 10¼"

75 mm x 65 mm

**AX 690-03** 26 cm / 10¼"

90 mm x 75 mm

**AX 690-04** 26 cm / 10¼"



**Doyen**

80 mm x 53 mm

**AX 700-25** 25 cm / 10"

**Wundhaken  
Retractors  
Separadores**

*Maße der Blätter: Tiefe x Breite*

*Dimensions of blades: Depth x Width*

*Dimensiones de las hojas: Profundidad x Anchura*



**Davidson**  
75 mm x 50 mm  
**AX 710-01** 16 cm / 6¼"



75 mm x 90 mm  
**AX 710-02** 16 cm / 6¼"



**Kocher**  
80 mm x 45 mm  
**AX 760-01** 25 cm / 10"

80 mm x 55 mm  
**AX 760-02** 25 cm / 10"

80 mm x 65 mm  
**AX 760-03** 25 cm / 10"

**Wundhaken**  
**Retractors**  
**Separadores**

*Maße der Blätter: Tiefe x Breite*

*Dimensions of blades: Depth x Width*

*Dimensiones de las hojas: Profundidad x Anchura*

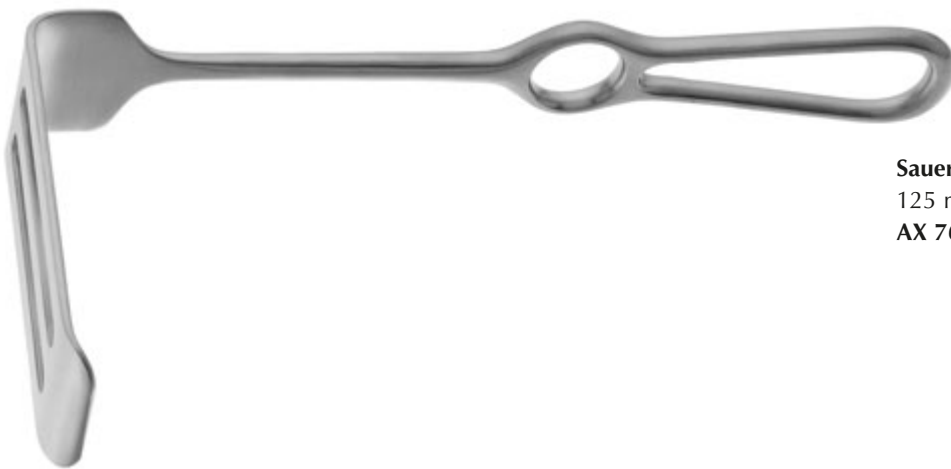

**Sauerbruch**  
125 mm x 37 mm  
AX 762-25 37 cm / 10"



**Mikulicz**  
95 mm x 35 mm  
AX 780-01 25 cm / 10"

120 mm x 50 mm  
AX 780-02 25 cm / 10"

150 mm x 50 mm  
AX 780-03 25 cm / 10"



**Mikulicz**  
90 mm x 55 mm  
AX 782-25 25 cm / 10"



**Wundhaken  
Retractors  
Separadores**

*Maße der Blätter: Tiefe x Breite*

*Dimensions of blades: Depth x Width*

*Dimensiones de las hojas: Profundidad x Anchura*



**Kelly**

160 mm x 38 mm

**AX 784-01** 27 cm / 10 $\frac{3}{4}$ "

160 mm x 57 mm

**AX 784-02** 27 cm / 10 $\frac{3}{4}$ "

190 mm x 38 mm

**AX 784-03** 27 cm / 10 $\frac{3}{4}$ "

190 mm x 57 mm

**AX 784-04** 27 cm / 10 $\frac{3}{4}$ "



**Harrington**

127 mm x 40 mm

**AX 790-01** 32 cm / 12 $\frac{1}{2}$ "

127 mm x 62 mm

**AX 790-02** 32 cm / 12 $\frac{1}{2}$ "



**Harrington-Pemberton**

175 mm x 64 mm

**AX 792-01** 32 cm / 12 $\frac{1}{2}$ "

**Wundhaken**  
**Retractors**  
**Separadores**

*Maße der Blätter: Tiefe x Breite*

*Dimensions of blades: Depth x Width*

*Dimensiones de las hojas: Profundidad x Anchura*



**Deaver**

Breite - width - anchura 19 mm

**AX 800-01** 18 cm / 7"



**Deaver**

Breite - width - anchura 22 mm

**AX 800-02** 21,5 cm / 8½"



**Deaver**

Breite - width - anchura 25 mm

**AX 800-03** 23 cm / 9"



**Deaver**

Breite - width - anchura 25 mm

**AX 800-04** 30 cm / 12"

**Wundhaken  
Retractors  
Separadores**

*Maße der Blätter: Tiefe x Breite*

*Dimensions of blades: Depth x Width*

*Dimensiones de las hojas: Profundidad x Anchura*



**Deaver**

Breite - width - anchura 25 mm

**AX 800-05** 33 cm / 13"



**Deaver**

Breite - width - anchura 25 mm

**AX 800-06** 36 cm / 14"



**Deaver**

Breite - width - anchura 38 mm

**AX 800-07** 30 cm / 12"



**Deaver**

Breite - width - anchura 50 mm

**AX 800-08** 30 cm / 12"



**Deaver**

Breite - width - anchura 75 mm

**AX 800-09** 30 cm / 12"

**Wundhaken**  
**Retractors**  
**Separadores**

*Maße der Blätter: Tiefe x Breite*

*Dimensions of blades: Depth x Width*

*Dimensiones de las hojas: Profundidad x Anchura*



**Deaver**  
Breite - width - anchura 25 mm  
**AX 810-01** 31 cm / 12½"



**Deaver**  
Breite - width - anchura 38 mm  
**AX 810-03** 31 cm / 12½"



**Deaver**  
Breite - width - anchura 50 mm  
**AX 810-04** 31 cm / 12½"



**Deaver**  
Breite - width - anchura 75 mm  
**AX 810-05** 31 cm / 12½"

**Atriumhaken**  
**Atrium Retractors**  
**Separadores para atrio**

*Maße der Blätter: Tiefe x Breite*

*Dimensions of blades: Depth x Width*

*Dimensiones de las hojas: Profundidad x Anchura*



**Cooley**

rechts – right – derecho

45 mm x 48 mm

**AX 820-01** 21,5 cm / 8½"



rechts, gerieft – right, serrated – derecho, estriado

45 mm x 48 mm

**AX 820-02** 21,5 cm / 8½"



links – left – izquierdo

24 mm x 48 mm

**AX 820-03** 21,5 cm / 8½"

**Bauchspatel**  
**Abdominal Spatulas**  
**Espátulos abdominales**



**Reverdin**

rostfrei - stainless steel - acero inoxidable  
Breiten - widths - anchuras 45 mm / 60 mm  
**AX 900-28** 28 cm / 11"



rostfrei - stainless steel - acero inoxidable  
biegsam - malleable - maleable

Breite - width - anchura 20 mm  
**AX 910-20** 33 cm / 13"

Breite - width - anchura 25 mm  
**AX 910-25** 33 cm / 13"

Breite - width - anchura 30 mm  
**AX 910-30** 33 cm / 13"

Breite - width - anchura 40 mm  
**AX 910-40** 33 cm / 13"

Breite - width - anchura 50 mm  
**AX 910-50** 33 cm / 13"



**Haberer**

rostfrei - stainless steel - acero inoxidable  
biegsam - malleable - maleable

Breiten - widths - anchuras 25 mm / 30 mm  
**AX 912-30** 28 cm / 11"

Breiten - widths - anchuras 40 mm / 50 mm  
**AX 912-50** 30 cm / 12"

**Bauchspatel**  
**Abdominal Spatulas**  
**Espátulos abdominales**



**Tuffier**

rostfrei - stainless steel - acero inoxidable  
biegsam - malleable - maleable  
Breiten - widths - anchuras 17 mm / 25 mm  
**AX 920-25** 20 cm / 8"



rostfrei - stainless steel - acero inoxidable  
biegsam - malleable - maleable  
Breite - width - anchura 6 mm  
**AX 950-06** 20 cm / 8"

Breite - width - anchura 9 mm  
**AX 950-09** 20 cm / 8"

Breite - width - anchura 12 mm  
**AX 950-12** 20 cm / 8"

Breite - width - anchura 17 mm  
**AX 950-17** 20 cm / 8"

Breite - width - anchura 20 mm  
**AX 950-20** 20 cm / 8"

Breite - width - anchura 25 mm  
**AX 950-25** 20 cm / 8"

**Wundsperrer**  
**Self-Retaining Retractors**  
**Separadores autostáticos**



**Finsen**

3 x 4 Zähne – 3 x 4 teeth – 3 x 4 dientes

stumpf – blunt – romos

**AZ 010-07** 7 cm / 2¾"

scharf – sharp – agudos

**AZ 014-07** 7 cm / 2¾"



**Heiss**

4 x 4 Zähne - 4 x 4 teeth - 4 x 4 dientes

stumpf - blunt - romos

**AZ 070-00** 10 cm / 4"

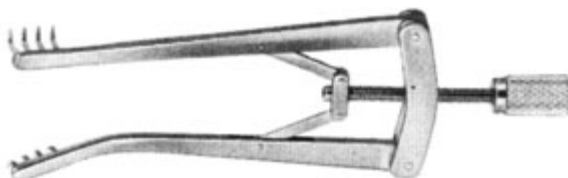

**Alm**

4 x 4 Zähne - 4 x 4 teeth - 4 x 4 dientes

stumpf - blunt - romos

**AZ 080-07** 7 cm / 2¾"

**AZ 080-10** 10 cm / 4"

scharf - sharp - agudos

**AZ 084-07** 7 cm / 2¾"

**AZ 084-10** 10 cm / 4"



**Wundsperrer**  
**Self-Retaining Retractors**  
**Separadores autostáticos**



**Jansen**

3 x 3 Zähne - 3 x 3 teeth - 3 x 3 dientes

stumpf - blunt - romos

**AZ 090-10** 10 cm / 4"

spitz - sharp - agudos

**AZ 094-10** 10 cm / 4"

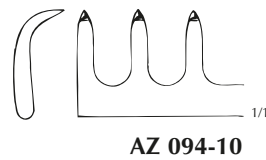
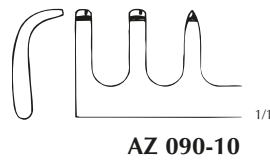

**Scalp-Contour**

3 x 4 Zähne - 3 x 4 teeth - 3 x 4 dientes

stumpf - blunt - romos

**AZ 096-14** 14 cm / 5½"

scharf - sharp - agudos

**AZ 098-14** 14 cm / 5½"

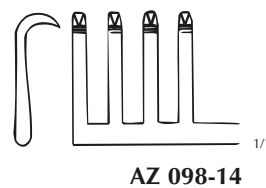
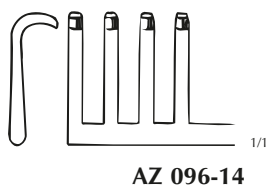

**Weitlaner**

2 x 3 Zähne - 2 x 3 teeth - 2 x 3 dientes

stumpf - blunt - romos

**AZ 100-10** 10,5 cm / 4¼"

scharf - sharp - agudos

**AZ 104-10** 10,5 cm / 4¼"

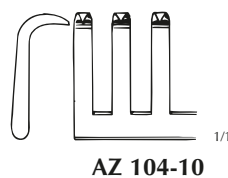
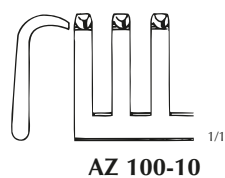

**Wundsperrer**  
**Self-Retaining Retractors**  
**Separadores autostáticos**

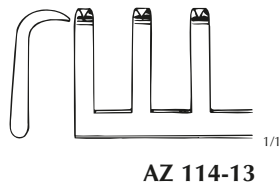
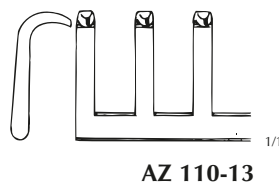

**Wullstein-Weitlaner**

3 x 3 Zähne - 3 x 3 teeth - 3 x 3 dientes

stumpf - blunt - romos

AZ 110-13 13 cm / 5"

scharf - sharp - agudos

AZ 114-13 13 cm / 5"

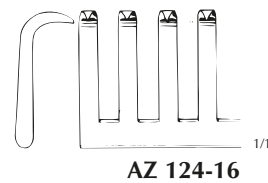
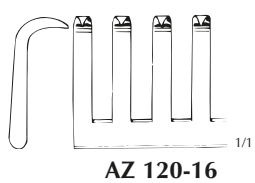
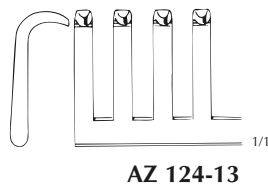
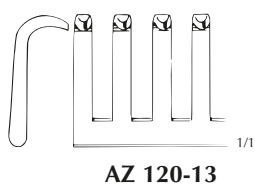

**Weitlaner**

3 x 4 Zähne - 3 x 4 teeth - 3 x 4 dientes

stumpf - blunt - romos

AZ 120-13 13 cm / 5"

AZ 120-16 16,5 cm / 6½"

scharf - sharp - agudos

AZ 124-13 13 cm / 5"

AZ 124-16 16,5 cm / 6½"

**Wundsperrer**  
**Self-Retaining Retractors**  
**Separadores autostáticos**



**Mollison**

4 x 4 Zähne – 4 x 4 teeth – 4 x 4 dientes

stumpf - blunt - romos

**AZ 160-15** 15 cm / 6"

scharf - sharp - agudos

**AZ 164-15** 15 cm / 6"

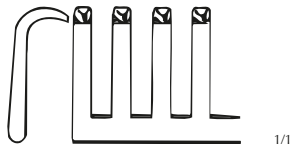

**AZ 160-15**

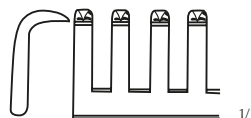

**AZ 164-15**



**Weitlaner**

3 x 4 Zähne - 3 x 4 teeth - 3 x 4 dientes

stumpf - blunt - romos

**AZ 170-20** 20 cm / 8"

**AZ 170-26** 26 cm / 10¼"

scharf - sharp - agudos

**AZ 174-20** 20 cm / 8"

**AZ 174-26** 26 cm / 10¼"

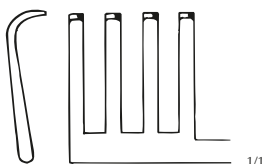

**AZ 170-20**

**AZ 170-26**

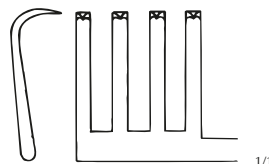

**AZ 174-20**

**AZ 174-26**

**Wundsperrer**  
**Self-Retaining Retractors**  
**Separadores autostáticos**

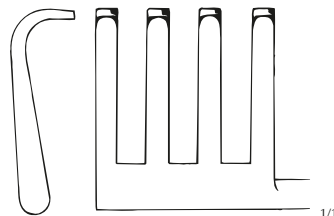

AZ 180-26

**Adson**

3 x 4 Zähne - 3 x 4 teeth - 3 x 4 dientes

stumpf - blunt - romos

AZ 180-26 26,5 cm / 10½"

scharf - sharp - agudos

AZ 184-26 26,5 cm / 10½"

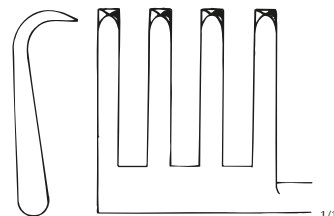

AZ 184-26

**Adson**

6 x 6 Zähne - 6 x 6 teeth - 6 x 6 dientes

stumpf - blunt - romos

AZ 190-26 26,5 cm / 10½"

scharf - sharp - agudos

AZ 194-26 26,5 cm / 10½"

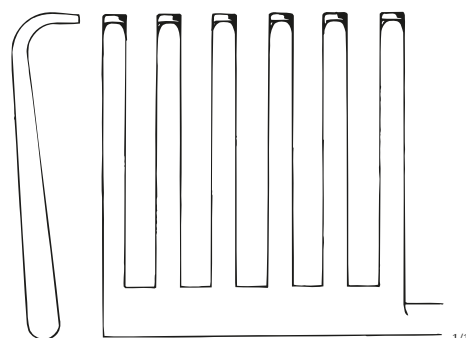

AZ 190-26

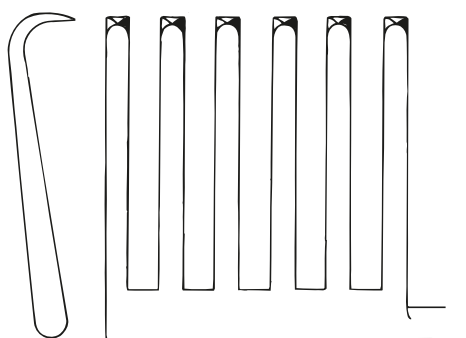

AZ 194-26

**Wundsperrer**  
**Self-Retaining Retractors**  
**Separadores autostáticos**

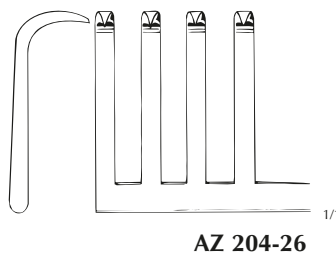
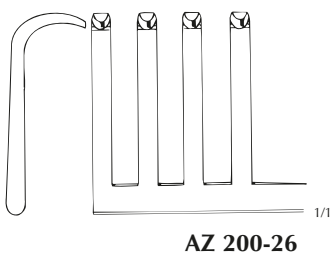
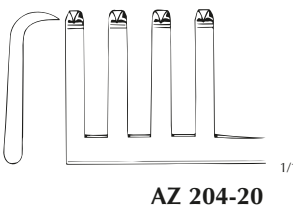
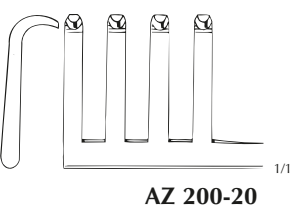
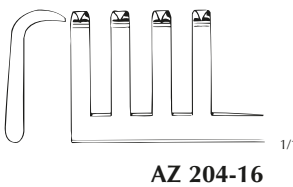
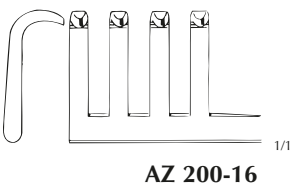
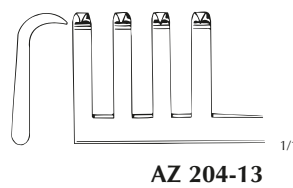
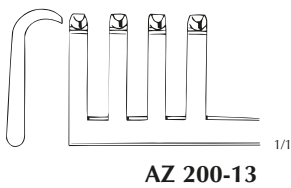

**Adson**

3 x 4 Zähne - 3 x 4 teeth - 3 x 4 dientes

stumpf - blunt - romos

**AZ 200-13** 13 cm / 5"

**AZ 200-16** 16 cm / 6¼"

**AZ 200-20** 20 cm / 8"

**AZ 200-26** 26 cm / 10¼"

scharf - sharp - agudos

**AZ 204-13** 13 cm / 5"

**AZ 204-16** 16 cm / 6¼"

**AZ 204-20** 20 cm / 8"

**AZ 204-26** 26 cm / 10¼"

**Wundsperrer**  
**Self-Retaining Retractors**  
**Separadores autostáticos**

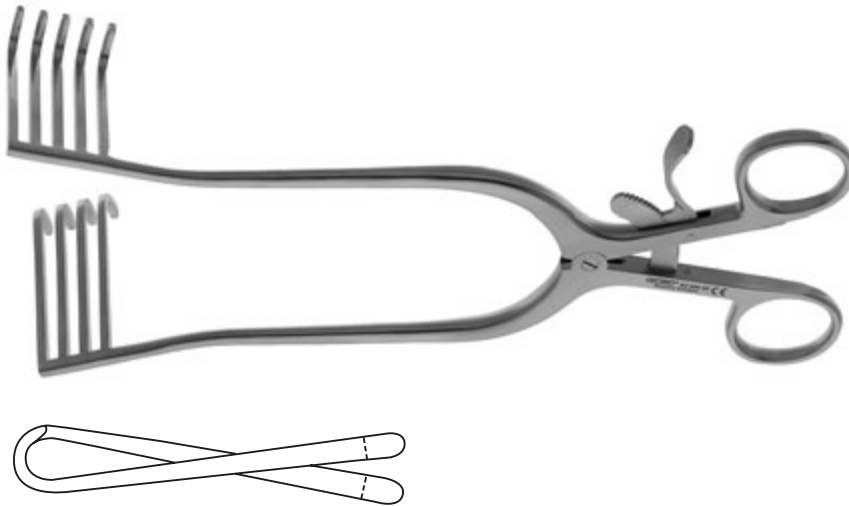

**Norfolk-Norwich**

4 x 5 Zähne - 4 x 5 teeth - 4 x 5 dientes

stumpf - blunt - romos

AZ 220-22 22 cm / 8¾"



**Beckmann**

4 x 4 Zähne - 4 x 4 teeth - 4 x 4 dientes

scharf - sharp - agudos

AZ 224-31 31 cm / 12¼"

**Wundsperrer**  
**Self-Retaining Retractors**  
**Separadores autostáticos**



**Adson**

4 x 5 Zähne - 4 x 5 teeth - 4 x 5 dientes

stumpf - blunt - romos

**AZ 230-32** 32 cm / 12½"

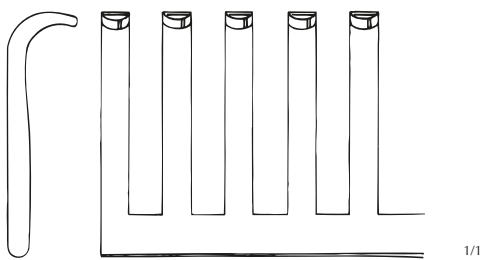

**Travers**

4 x 5 Zähne - 4 x 5 teeth - 4 x 5 dientes

stumpf - blunt - romos

**AZ 240-20** 20 cm / 8"

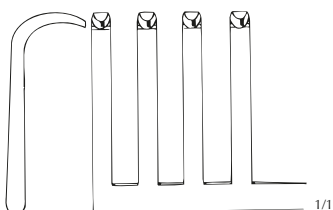

**Wundsperrer**  
**Self-Retaining Retractors**  
**Separadores autostáticos**



**Beckmann-Eaton**

7 x 7 Zähne - 7 x 7 teeth - 7 x 7 dientes

scharf - sharp - agudos

**AZ 244-32** 32 cm / 12¾"

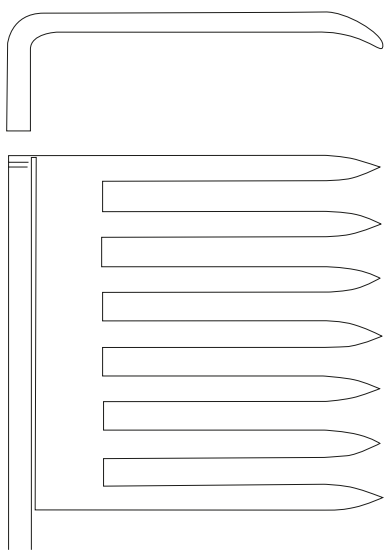

1/1



**Wundsperrer**  
**Self-Retaining Retractors**  
**Separadores autostáticos**



**Gelpi**

**AZ 270-13** 13 cm / 5"

**AZ 270-18** 18 cm / 7"



**Gelpi**

mit Kugeln - with balls - con bolas

stumpf - blunt - romo

**AZ 272-18** 18 cm / 7"

scharf - sharp - agudo

**AZ 274-18** 18 cm / 7"



**Gelpi-Seiletz**

stumpf - blunt - romo

**AZ 280-15** 15 cm / 6"

scharf - sharp - agudo

**AZ 284-15** 15 cm / 6"

**Wundsperrer**  
**Self-Retaining Retractors**  
**Separadores autostáticos**



**Plester**

Blatt rechts, 2 stumpfe Zähne links

Blade right, 2 blunt teeth left

Valva derecha, 2 dientes izquierda romos

**AZ 290-11** 11 cm / 4¼"

Blatt links, 2 stumpfe Zähne rechts

Blade left, 2 blunt teeth right

Valva izquierda, 2 dientes derecha romos

**AZ 292-11** 11 cm / 4¼"



**Plester**

2 x 2 Zähne – 2 x 2 teeth – 2 x 2 dientes

stumpf – blunt – romos

**AZ 296-13** 13 cm / 5"

scharf – sharp – agudos

**AZ 299-13** 13 cm / 5"

## Bauchdeckenhalter Abdominal Retractors Separadores abdominales

*Maße der Blätter: Tiefe x Breite*

*Dimensions of blades: Depth x Width*

*Dimensiones de las hojas: Profundidad x Anchura*



### Baby-Collin

komplett - complete - completo

**AZ 300-00**

bestehend aus - including - compuesto de:

Sperrer allein - frame only - cuadro solo

Spreizweite - spread - abertura 80 mm / 3 1/4"

**AZ 301-01**

Seitenvalve - lateral blade - valva lateral

2 x **AZ 303-23** 23 mm x 40 mm

2 x **AZ 303-30** 30 mm x 40 mm



### Collin

komplett - complete - completo

**AZ 350-00**

bestehend aus - including - compuesto de:

Sperrer allein - frame only - cuadro solo

Spreizweite - spread - abertura 100 mm / 4"

**AZ 351-01**

Mittelvalve - center blade - valva central

**AZ 352-38** 55 mm x 55 mm

Seitenvalve - lateral blade - valva lateral

2 x **AZ 353-38** 32 mm x 62 mm

*Zubehör - accessories - accesorios:*

Mittelvalve - center blade - valva central

**AZ 352-50** 50 mm x 75 mm

Seitenvalve - lateral blade - valva lateral

**AZ 353-40** 40 mm x 80 mm

**AZ 353-45** 45 mm x 80 mm

**Bauchdeckenhalter**  
**Abdominal Retractors**  
**Separadores abdominales**

*Maße der Blätter: Tiefe x Breite*

*Dimensions of blades: Depth x Width*

*Dimensiones de las hojas: Profundidad x Anchura*

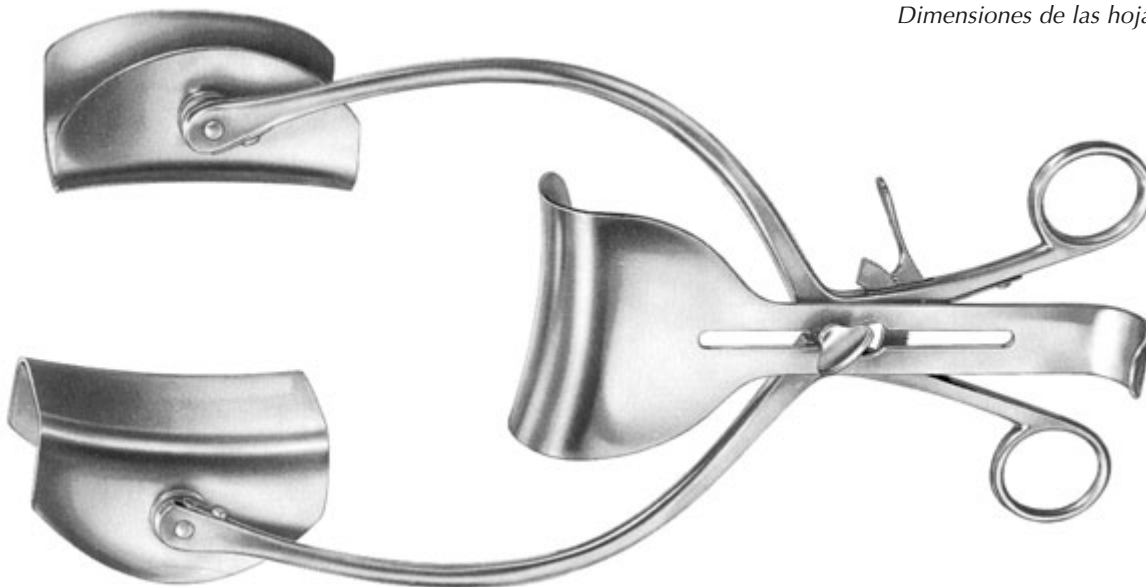

**Collin**

komplett - complete - completo

**AZ 360-00**

bestehend aus - including - compuesto de:

Sperrer allein - frame only - cuadro solo

Spreizweite - spread - abertura 160 mm / 6¼"

**AZ 361-01**

Mittelvalve - center blade - valva central

**AZ 362-60** 60 mm x 75 mm

Seitenvalve - lateral blade - valva lateral

2 x **AZ 363-60** 60 mm x 80 mm

**Bauchdeckenhalter**  
**Abdominal Retractors**  
**Separadores abdominales**

*Maße der Blätter: Tiefe x Breite*

*Dimensions of blades: Depth x Width*

*Dimensiones de las hojas: Profundidad x Anchura*



**Henley**

komplett 3 x 4 Zähne stumpf  
complete 3 x 4 teeth blunt  
completo 3 x 4 dientes romos  
16,5 cm / 6½"

**AZ 370-00**

bestehend aus - including - compuesto de:

Sperrer allein - frame only - cuadro solo

**AZ 371-01**

Mittelvalve - center blade - valva central

**AZ 372-19** 16 mm x 19 mm

Mittelvalve - center blade - valva central

**AZ 372-25** 16 mm x 25 mm

Mittelvalve - center blade - valva central

**AZ 372-32** 16 mm x 32 mm

**Henley**

komplett 3 x 4 Zähne scharf  
complete 3 x 4 teeth sharp  
completo 3 x 4 dientes agudos  
16,5 cm / 6½"

**AZ 374-00**

bestehend aus - including - compuesto de:

Sperrer allein - frame only - cuadro solo

**AZ 374-01**

Mittelvalve - center blade - valva central

**AZ 372-19** 16 mm x 19 mm

Mittelvalve - center blade - valva central

**AZ 372-25** 16 mm x 25 mm

Mittelvalve - center blade - valva central

**AZ 372-32** 16 mm x 32 mm

**Bauchdeckenhalter**  
**Abdominal Retractors**  
**Separadores abdominales**



*Maße der Blätter: Tiefe x Breite*

*Dimensions of blades: Depth x Width*

*Dimensiones de las hojas: Profundidad x Anchura*

**Gosset**

Spreizweite - spread - abertura 100 mm / 4"  
Seitenvalven - lateral blades - valvas laterales  
38 mm x 19 mm

**AZ 400-00**

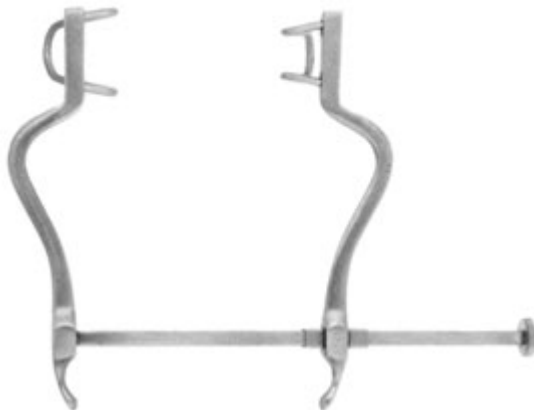

**Gosset**

Spreizweite - spread - abertura 140 mm / 5 1/4"  
Seitenvalven - lateral blades - valvas laterales  
64 mm x 25 mm

**AZ 410-00**



**Gosset**

komplett - complete - completo

**AZ 420-00**

bestehend aus - including - compuesto de:

Sperrer mit Seitenvalven 63 mm x 35 mm  
frame with lateral blades 63 mm x 35 mm  
cuadro con valvas laterales 63 mm x 35 mm

Spreizweite - spread - abertura 160 mm / 6 1/4"

**AZ 421-01**

Mittelvalve - center blade - valva central

**AZ 422-70** 60 mm x 56 mm

## Bauchdeckenhalter Abdominal Retractors Separadores abdominales

*Maße der Blätter: Tiefe x Breite*

*Dimensions of blades: Depth x Width*

*Dimensiones de las hojas: Profundidad x Anchura*

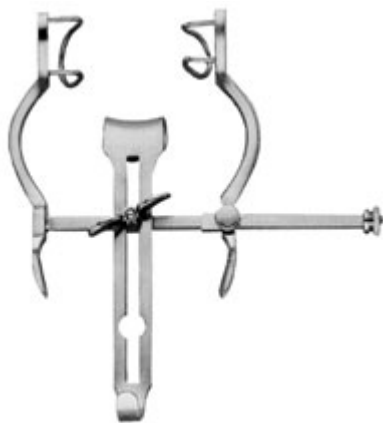

### **Baby-Balfour**

komplett - complete - completo

**AZ 450-00**

bestehend aus - including - compuesto de:

Sperrer mit Seitenvalven 27 mm x 27 mm  
frame with lateral blades 27 mm x 27 mm  
cuadro con valvas laterales 27 mm x 27 mm

Spreizweite - spread - abertura 90 mm / 3½"  
**AZ 451-01**

Mittelvalve - center blade - valva central  
**AZ 452-24** 24 mm x 20 mm



### **Balfour**

komplett - complete - completo

**AZ 460-00**

bestehend aus - including - compuesto de:

Sperrer mit Seitenvalven 63 mm x 35 mm  
frame with lateral blades 63 mm x 35 mm  
cuadro con valvas laterales 63 mm x 35 mm

Spreizweite - spread - abertura 180 mm / 7"  
**AZ 461-01**

Mittelvalve - center blade - valva central  
**AZ 462-45** 45 mm x 80 mm

**Bauchdeckenhalter**  
**Abdominal Retractors**  
**Separadores abdominales**



*Maße der Blätter: Tiefe x Breite*

*Dimensions of blades: Depth x Width*

*Dimensiones de las hojas: Profundidad x Anchura*

**Balfour**

komplett - complete - completo

**AZ 470-00**

bestehend aus - including - compuesto de:

Sperrer mit Seitenvalven 70 mm x 35 mm  
frame with lateral blades 70 mm x 35 mm  
cuadro con valvas laterales 70 mm x 35 mm

Spreizweite - spread - abertura 180 mm / 7"  
**AZ 471-01**

Mittelvalve - center blade - valva central  
**AZ 462-45** 45 mm x 80 mm



**Balfour**

komplett - complete - completo

**AZ 480-00**

bestehend aus - including - compuesto de:

Sperrer mit Seitenvalven 100 mm x 35 mm  
frame with lateral blades 100 mm x 35 mm  
cuadro con valvas laterales 100 mm x 35 mm

Spreizweite - spread - abertura 200 mm / 8"  
**AZ 481-01**

Mittelvalve - center blade - valva central  
**AZ 482-99** 100 mm x 60 mm



## Bauchdeckenhalter Abdominal Retractors Separadores abdominales

*Maße der Blätter: Tiefe x Breite*

*Dimensions of blades: Depth x Width*

*Dimensiones de las hojas: Profundidad x Anchura*

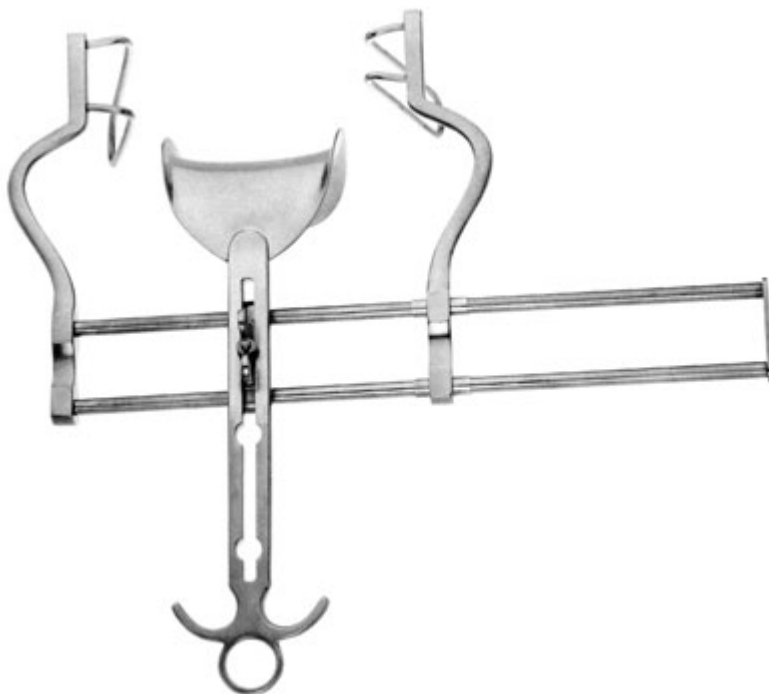

### **Balfour**

komplett - complete - completo

**AZ 490-00**

bestehend aus - including - compuesto de:

Sperrer mit Seitenvalven 100 mm x 35 mm  
frame with lateral blades 100 mm x 35 mm  
cuadro con valvas laterales 100 mm x 35 mm

Spreizweite - spread - abertura 250 mm / 10"  
**AZ 491-01**

Mittelvalve - center blade - valva central  
**AZ 492-70** 70 mm x 85 mm

**Bauchdeckenhalter**  
**Abdominal Retractors**  
**Separadores abdominales**



*Maße der Blätter: Tiefe x Breite*

*Dimensions of blades: Depth x Width*

*Dimensiones de las hojas: Profundidad x Anchura*

**Balfour-USA**

komplett - complete - completo

**AZ 500-00**

bestehend aus - including - compuesto de:

Sperrer allein - frame only - cuadro solo

Spreizweite - spread - abertura 180 mm / 7"

**AZ 501-01**

Mittelvalve - center blade - valva central

**AZ 502-45** 70 mm x 85 mm

Mittelvalve - center blade - valva central

**AZ 502-68** 68 mm x 84 mm

Seitenvalven (Paar), 50 mm tief

Lateral blades (pair), 50 mm deep

Valvas laterales (par), 50 mm de profundo

**AZ 503-06**

Seitenvalven (Paar) , 75 mm tief

Lateral blades (pair) , 75 mm deep

Valvas laterales (par), 75 mm de profundo

**AZ 503-08**

**Bauchdeckenhalter**  
**Abdominal Retractors**  
**Separadores abdominales**

*Maße der Blätter: Tiefe x Breite*

*Dimensions of blades: Depth x Width*

*Dimensiones de las hojas: Profundidad x Anchura*



**O'Sullivan-O'Connor**  
komplett - complete - completo  
**AZ 700-00**

bestehend aus - including - compuesto de:

Sperrer mit Seitenvalven  
frame with lateral blades  
cuadro con valvas laterales  
**AZ 701-01**

Mittelvalve - center blade - valva central  
2 x **AZ 702-80** 90 mm x 45 mm

Mittelvalve - center blade - valva central  
**AZ 702-99** 100 mm x 70 mm

**Bauchdeckenhalter**  
**Abdominal Retractors**  
**Separadores abdominales**



**Rochard**

Befestigungsrahmen 65 cm hoch, 55 cm tief  
Mounting frame 65 cm high, 55 cm deep  
Bastidor para la fijación altura 65 cm,  
profundida 55 cm

**AZ 741-01** 65 cm x 55 cm



**Rochard**

Bauchdeckenhalter  
Abdominal retractors  
Separadores abdominales

**AZ 742-01** 50 mm x 95 mm

**AZ 742-02** 50 mm x 105 mm

**AZ 742-03** 60 mm x 120 mm

**AZ 742-04** 60 mm x 135 mm

**AZ 742-05** 60 mm x 155 mm



**Rochard**

Fixiervorrichtung  
Fixation device  
Dispositivo de fijación

**AZ 745-19** 19 cm / 7½"

## Bauchdeckenhalter Abdominal Retractors Separadores abdominales

Maße der Blätter: Tiefe x Breite

Dimensions of blades: Depth x Width

Dimensiones de las hojas: Profundidad x Anchura



AZ 751-01

### Kirschner

komplett - complete - completo

**AZ 750-00**

bestehend aus - including - compuesto de:

Rahmen allein - frame only - cuadro solo

**AZ 751-01** 300 mm x 240 mm

Rahmenhaken - frame hook - valva de cuadro  
3 x **AZ 752-50** 50 mm x 65 mm

Rahmenhaken - frame hook - valva de cuadro  
**AZ 752-80** 80 mm x 90 mm

Rahmenhaken - frame hook - valva de cuadro  
**AZ 752-98** 98 mm x 50 mm

Rahmenhaken - frame hook - valva de cuadro  
**AZ 752-99** 105 mm x 35 mm

### Zubehör - accessories - accesorios:

Rahmenhaken - frame hook - valva de cuadro  
**AZ 752-60** 60 mm x 85 mm

Rahmenhaken - frame hook - valva de cuadro  
**AZ 752-78** 78 mm x 65 mm



AZ 752-50  
AZ 752-60  
AZ 752-78  
AZ 752-80



AZ 752-98  
AZ 752-99

**Bauchdeckenhalter**  
**Abdominal Retractors**  
**Separadores abdominales**

*Maße der Blätter: Tiefe x Breite*

*Dimensions of blades: Depth x Width*

*Dimensiones de las hojas: Profundidad x Anchura*



**Kirschner**

komplett - complete - completo

**AZ 760-00**

bestehend aus - including - compuesto de:

Rahmen allein - frame only - cuadro solo

**AZ 761-02** 240 mm x 240 mm

Rahmenhaken - frame hook - valva de cuadro

2 x **AZ 752-40** 40 mm x 55 mm

Rahmenhaken - frame hook - valva de cuadro

2 x **AZ 752-50** 50 mm x 65 mm



## Chirurgische Armsysteme mit hoher Haltekraft Surgical Arm Systems with Strong Holding Power Sistemas de brazo con firmeza grande



Bitte fordern Sie unseren Prospekt an.  
Please contact us for detailed information.  
Para más informaciones por favor informemos.

- die Feststellung des Armsystems ist stufenlos einstellbar und erlaubt in jeder Position das Fixieren des Systems
- es können alle Wundhaken verwendet werden – daher bieten die ASSISTO®-Armsysteme dem Anwender auch einen großen wirtschaftlichen Vorteil
- alle Armsysteme und Komponenten sind wartungsfrei, einfach zu reinigen und komplett autoklavierbar bei 134° C
- umfassendes Zubehörprogramm für Chirurgie, Endoskopie, Anästhesie und Intensivpflege
- 10 Jahre Garantie auf Material und Verarbeitung

*For more than 20 years GEOMED® Medizin-Technik has been dealing with the research, development and manufacture of powerful surgical and multi-purpose arm systems. These all-purpose holding systems were taken out as patent for the first time in 1977. For the newly developed ASSISTO® Arm System – for which patents are pending in Europe, the USA and Japan – there could be achieved a major improvement in technical and practical performance which offers the following advantages to the user:*

Seit über 20 Jahren beschäftigt sich GEOMED® Medizin-Technik mit der Entwicklung und Herstellung von leistungsstarken Armsystemen. Diese universellen Haltesysteme wurden erstmals 1977 patentiert. Mit der jetzt vorliegenden Neuentwicklung – die in Europa, USA und Japan zum Patent angemeldet ist – konnte eine wesentliche konstruktive Verbesserung erreicht werden, die dem Anwender folgende Vorteile bietet:

- schnelle, präzise und stabile Fixierung aller Systeme mit nur einem Zentralgelenk
- Haltekraft gegenüber herkömmlichen Systemen verdreifacht und damit deutlich sicherer für Arzt und Patient

- *swift, accurate and solid positioning and locking of all Arm Systems by way of one central joint*
- *holding power is tripled compared to standard systems which offers additional safety to the physician and the patient*
- *locking of Arm System is continuously adjustable and allows its fixation in any required position*

- *any type of retractor is easy to apply offering the user a major economic benefit*
- *the entire arm system and its working elements are maintenance-free, easy to be cleaned and fully autoclavable up to 134° C*
- *complete range of accessories for surgery, endoscopy, anesthesia and intensive care medicine available*
- *10 year guarantee on material and workmanship*



